

1 September 2021

ASX ANNOUNCEMENT**ASX: ASN****OTC: ANSNF****Paradox Brine Stage 1 Sodium Bromide/Lithium Updated PEA****Highlights:**

- **Continuous margins improvement program results in more efficient production processes for both lithium carbonate and sodium bromide**
- **Substantial reduction in lithium carbonate and sodium bromide operating cost estimates**
- **Environmental, Social & Governance (ESG) considerations impact upon capex estimates but deliver a more sustainable project**
- **Overall changes result in Pre-tax Net Present Value (NPV) improvement**

Anson Resources Limited (“Anson”) is pleased to announce that it has updated its Preliminary Economic Assessment (“PEA”) for Phase 1 of its Paradox Brine Project, located Utah, USA (the Project). An additional engineering study conducted by a third party as part of a Pre-feasibility Study (PFS) has resulted in improvements in the sodium bromine (NaBr) production process and due to more accurate capex and opex estimates.

CAUTIONARY STATEMENTS

The PEA is a preliminary technical and economic study of the potential viability of the Paradox Brine Project required to reach a decision to proceed with more definitive studies (equivalent to a JORC Scoping Study). It is based on preliminary/low-level technical and economic assessments that are not sufficient to support the estimation of Ore Reserves or provide certainty that the conclusions/results of the PEA will be realised. Further exploration and evaluation work and appropriate studies are required before Anson will be in a position to estimate any Ore Reserves or to provide any assurance of an economic development case.

The economic analysis results should be treated as preliminary in nature and caution should be exercised in their use as a basis for assessing project feasibility. The PEA was based on material assumptions including assumptions about the availability of funding. While Anson considers all the material assumptions to be based on reasonable grounds, there is no certainty that they will prove be correct or that the range of outcome indicated by the PEA will be achieved.

To achieve the range of proposed feasibility studies and potential project development outcomes indicated in the PEA, additional funding of US\$203 million will be required after exploration has been completed. Investors should note that there is no certainty that Anson will be able to raise funding when needed. It is also possible that such funding may only be available on terms that may be dilutive to or otherwise affect the value of Anson’s existing shares. It is also possible that Anson could pursue other “value realisation” strategies such as a sale, partial sale or joint venture of the project. If it does, this could materially reduce Anson’s proportionate ownership of the project.

100% of bromine and 100% of lithium included in the PEA for Phase 1 proposed mining schedules is included within Indicated Mineral Resources.

For personal use only

Process and engineering works for the PEA were developed to support capital and operating estimates (and following AUSIMM Guidelines for this study level) and given the preliminary and confidential nature of the plant information the capital cost includes a margin of error of +/- 50%.

The PEA includes work that was performed by a third-party engineering company in the development of a Prefeasibility Study (PFS) for the sodium bromine plant (NaBr) which has been concluded. The company expect to soon commence on a Prefeasibility Study (PFS) for the Stage 1 2,674tpa lithium carbonate equivalent (LCE) plant which is to be built in conjunction with the NaBr plant. The results of this study will be combined with the results of the Stage1 15,000tpa NaBr PFS and announced through the ASX once it has been completed. It should also be noted that this revised PEA study also includes results of the using the alternative Direct Lithium Extraction (DLE) technology, see ASX announcement released on 13 August 2021.

Key assumptions that the PEA is based on are outlined in the body of this announcement. Anson has concluded it has a reasonable basis for providing the forward-looking statements in this announcement.

The Mineral Resources information in this report is consistent with that in the announcement entitled *Anson Further De-Risks Paradox Brine Project* released on 11 May 2020. Anson confirms that it is not aware of any new information or data that materially affects the information included in the original market announcement and, in the case of the Mineral Resources or Ore Reserves, that all material assumptions and technical parameters underpinning the estimates in the relevant market announcement continue to apply and have not materially changed. Anson confirms that the form and context which the Competent Person's findings are presented have not been materially modified from the original market announcement.

There is a high level of geological confidence associated with the indicated mineral resources in which 100% of the bromine and 100% of the lithium production will be taken. The stated production target is based on the Company's current expectations of future results or events and should not be solely relied upon by investors when making investment decisions. Further evaluation work and appropriate studies are required to establish sufficient confidence that this target will be met.

Given the uncertainties involved, all figures, costs, estimates quoted are approximate values and within the margin of error range expressed in the relevant sections throughout this announcement. Investors should not make any investment decisions based solely on the results of the PEA.

The PEA, equivalent to a JORC Scoping Study, provides outcomes that are considered outstanding. **The NaBr cash cost has been decreased by 67% to USD377/t net of by-product revenue.** No adjustment has been made to the NaBr sales price.

A review of the Project to incorporate an alternative direct lithium extraction process which achieved a recovery of up to 91.5% without chemical washing and pre-treatment of brine (see ASX *Announcement of 13 August 2021*) has been used in this PEA. The increase in the lithium recovery rate has increased the estimated production tonnes of LCE in Stage 1 of the Project to 2,674tpa contributing to an overall improvement in Project economics. Due to the improvement is the process flow sheet incorporating the alternative Direct Lithium Extraction (DLE) **the cash cost for the production of lithium has been reduced by 47% to USD2,431/t net of by-product revenue.** To reflect the rising demand for lithium carbonate, the sales price in the PEA has been increased to USD15,000/t.

In addition, an environmental, social and governance review of the Project identified areas for improvement and these have also been included in the updated PEA. These changes have contributed to a 14.7% increase in capex estimates to USD203 million.

Key financial highlights only Phase 1 PEA are presented in Table 1:

(USD)	PRE-TAX		POST-TAX	
	NPV (7%)	IRR	NPV (7%)	IRR
Updated Stage 1 PEA – NaBr and LCE	\$650m	38%	\$468m	31%

Table 1: Paradox Brine Project Phase 1 PEA Key financial highlights

Summary of Key PEA Parameters and Outcomes

Key outcomes and parameters of the PEA are presented in Table 2 below.

Production Parameters	Units	Phase 1
Construction Period	Years	2
Production Rate - NaBr	Tonnes per annum	15,000
Production Rate – Li ₂ CO ₃	Tonnes per annum	2,674
Mineral Resource – Bromine	Contained ('000t)	1,176
Mineral Resource – Li ₂ CO ₃	Contained ('000t)	192
Production Rate – Brine Extraction	Litres per minute	7,000
Recovery – NaBr	%	90
Recovery – Li ₂ CO ₃	%	81
Key Financial Parameters		
Capital Cost	\$US Million	203
Operating Cost – Per annum	\$US Million	32
Price – NaBr	\$US/tonne	5,280
Price – Li ₂ CO ₃	\$US/tonne	15,000
Price - NaOH	\$US/tonne	675
Price – Boric Acid	\$US/tonne	710
Sales – Annual – NaBr	\$US Million	79
Sales – Annual – Li ₂ CO ₃	\$US Million	40
Sales – Annual - NaOH	\$US Million	7
Sales – Annual – Boric Acid	\$US Million	2
Sales – Annual (steady production rate)	\$US Million	129
Sales – 20 years assumed	\$US Million	2,552
Cash Cost, net of by-product revenue	\$US/tonne NaBr	377
Cash Cost, net of by-product revenue	\$US/tonne Li ₂ CO ₃	2,431
EBITDA Margin	%	75
EBITDA – Annual	\$US Million	97
EBITDA – 20 years assumed	\$US Million	1,917
Payback period	Years	2
IRR Post Tax	%	31

NPV (7%) post tax (Base Case)	\$US Million	468
-------------------------------	--------------	-----

Table 2: Paradox Brine Project key parameters and outcomes

The PEA is to an accuracy of +/- 50%. Therefore, the financial outcomes may vary depending on the inputs values that are realised. The sensitivity analysis in Graph 1 detail the effect on financial outcomes (NPV in USD) from a change in the value of key inputs.

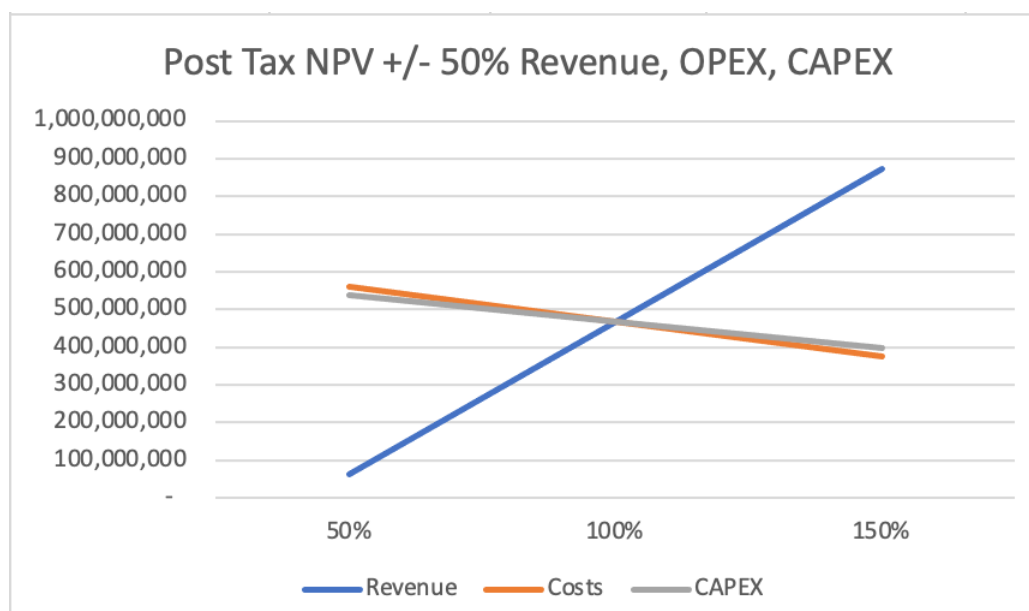

Graph 1: Paradox Brine Project NPV Sensitivity Analysis

The table below shows a summary of contained tonnes for Br, NaBr and Li₂CO₃ extracted from JORC estimate, see ASX announcement “Anson Further De-Risks Paradox Brine Project” released on 11 May 2020.

Resource Category	Clastic Zone	Brine Tonnes (Mt)	Contained ('000t) ¹		
			Li ₂ CO ₃	BR ₂	NaBr
Indicated	31	37	34	143	185
Indicated	17,19,29,33	39	16	142	183
Total Indicated Resource		76	50	285	368
Inferred	31	74	68	221	285
Inferred	17,19,29,33	191	74	670	864
Total Inferred Resource		265	142	891	1,149
Total Resource		341	192	1,176	1,517

Table 3: Table showing the contained tonnes in Indicated and Inferred Categories.

¹ Lithium is converted to lithium carbonate (Li₂CO₃) using a conversion factor of 5.32 and Br₂ to NaBr using a conversion factor of 1.29. Rounding errors may occur.

Below is a table that shows the product proportions of Indicated and Inferred Resource categories to be used for Phase 1 of production.

Phase	Br – Indicated (%)	Br – Inferred (%)	Li – Indicated (%)	Li – Inferred (%)
Phase 1	100	-	100	-

Table 4: Table summarising the tonnages of Br and Li₂CO₃ required in Phase 1.

Relevant Information Concerning PEA Preparation

The PEA referred to in this announcement is based on the Mineral Resource (see announcement titled *'Anson further de-risks Paradox Brine Project'* of 11 May 2020), which provides the total tonnage underpinning the forecast production target and financial projections, updated for a reduction in the project area following the relinquishment of claims subsequent to this date. The estimated Indicated Mineral Resource underpinning the production target has been prepared by a Competent Person in accordance with the requirements of the JORC Code. Accordingly, Anson has concluded that it has reasonable grounds for disclosing the production targets.

The PEA includes work that was performed by a third-party engineering company in the development of a Prefeasibility Study (PFS) for the sodium bromine plant (NaBr) which has been concluded. The Company expects to soon commence on a Prefeasibility Study (PFS) for the Stage 1, 2,674tpa lithium carbonate equivalent (LCE) plant which is to be built in conjunction with the NaBr plant. The results of this study will be combined with the results of the Stage 1, 15,000tpa NaBr PFS and announced through the ASX once it has been completed. It should also be noted that this revised PEA study also includes results of the using the alternative Direct Lithium Extraction (DLE) technology, see ASX announcement 13 August 2021.

The capital and operating costs from the well-heads to the disposal wells for the NaBr plant were prepared by independent and globally recognised engineering firm Worley and the capital and operating costs were for the lithium carbonate plant were estimated internally based on equipment quotes from suppliers and installation costs estimated by Millcreek Engineering in the earlier PEA. Processing and engineering works for the PEA were developed to support capital and operating estimates (and following AUSIMM Guidelines for this study level) and given the preliminary and confidential nature of the plant information, the capital cost has a margin of error of +/- 50%.

The pricing for commodities used in the PEA was based on independent market research and the economic analysis results should be treated as preliminary in nature and caution should be exercised in their use as a basis for assessing project feasibility.

Forward Looking Statements: Statements regarding plans with respect to Anson's mineral properties are forward looking statements. There can be no assurance that Anson's plans for development of its mineral properties will proceed as expected. There can be no assurance that Anson will be able to confirm the presence of mineral deposits, that any mineralisation will prove to be economic or that a mine will be successfully developed on any of Anson's mineral properties.

Unless otherwise stated, all cashflows are in US Dollars, are undiscounted and are not subject to inflation/escalation factors, and all years are calendar years.

Details of the PEA

The PEA was prepared for Anson's Paradox Brine Project, located in Utah, USA, based on production of 15,000tpa of NaBr and 2,674tpa of Li_2CO_3 .

The cost data basis used for the compilation of the indicative Paradox Brine Project capital expenditure and operating expenditure require further detail/development in order to improve the confidence level and accuracy of the estimates.

In addition to revenue from NaBr, revenue is expected to be earned from the sale of a by-product, 11,044tpa caustic soda (NaOH) and 2,982tpa of boric acid (H_3BO_3).

Potential additional by-product revenue from production of iodine (I_2) and other possible by-products have not been included.

Key Risks

Permitting

A Plan of Operations (PoO) has been submitted to the Bureau of Land Management (BLM), Department of Interior, Government of the United States of America, for the re-entry of two wells for additional test work and is progressing through the approval process. An Environmental Assessment is required as part of the PoO process and the Company has appointed an environmental consultant to undertake this work which is expected to be completed in Q3 2021. Current BLM policy dictates a timeline of six months for completion of the consideration of the PoO.

An Application for Permit to Drill (APD) has also been submitted to the Schools Institutional Trust Administration (SITLA), Government of Utah and the Notice of Intent to Conduct Exploration (NoI) Application for Permit to Drill (APD) to the State of Utah Department of Natural Resources, Division of Oil & Gas (UDOGM) for two planned production wells. This application is proceeding through the approval process.

In addition, a PoO will also need to be submitted to the BLM to apply for the use of an existing pipeline corridor to transport brine from the well field to the processing plant. Separate applications are also required for the use of surface area for access corridors for utilities including power, natural gas, transport roads and other potential inputs to the processing plant that cross state lands.

A list of permits required is appended in Annexure A.

General Environmental Risks

The Project's proposed location near Moab and other environmental sensitive receptors results in some general environmental risks associated with permitting. The overall Moab area is highly prized for its scenery and varied recreational activities. The area is known for two National Parks, a certified Dark Skies State Park, and numerous yearly rallies attracting many visitors. The Project borders the Labyrinth Rims/Gemini Bridges Special Recreational Management Area (SRMA). Additionally, the project is within Class II and III Visual Resource Management Areas.

Anson as part of its **Environmental, Social Governance (ESG)** policy in establishing a sustainable project has taken measures to mitigate the impact on the environment and recreational activities by using areas where there has already been environmental disturbance such as pipeline corridors, utility corridors as well as reducing above and below ground gathering lines and the number of well pads reducing the impact of the project on recreational activities.

The company plans to use the existing pressure to transport the brine to a processing location approximately 30 miles (~48km) from the extraction locations to not only reduce impact on recreational activity in the area and the visual impact upon the environment with only well heads appearing above ground but also reduce emissions by not requiring fuel for pumping and the transport of the fuel to these less locations.

The location of the brine processing plant has also been selected to minimize the impact on the environment by utilising existing utility infrastructure that has already created ground disturbance and visual impact. The planned plant location is within close proximity to existing power transmission lines and gas pipelines. In addition, the planned plant location is close to an existing commercial airport,

Anson is continuing to examine other mitigation measures to improve the sustainability of the project.

Economic Analysis

A financial model has been prepared for the production of 15,000tpa sodium bromide and 2,674tpa lithium carbonate.

Assumptions

- The Project is expressed in constant (2021) US\$.
- Project economics (revenues and costs) are un-inflated and un-escalated.
- Economic evaluation metrics are reported including net present value (NPV), and internal rate-of-return (IRR).
- The NPV is estimated at discount rates of 7%.
- The analysis does not include any costs for interest on debt, nor does the model assume any advantages from debt financing.
- No provision has been made for capex contingencies (not included in previous PEA estimates).
- An OPEX contingency of 15% has been included.

Production Criteria

- The economic model assumes a two-year pre-production (construction) period.
- The analysis considers the pre-production (initial construction) years and the following 20 years of project life. It can be assumed that the resource life can continue beyond Year 20.
- Estimated permitting costs and drilling costs are brought forward to the beginning of the pre-production construction period of the economic model.
- Pre-production, exploration, and other sunk costs spent to date are not included in the model. The capital portion of these costs has been included in the depreciation.

Pricing

- Sodium bromide \$5,280/t.
- Lithium carbonate \$15,000/t.
- Caustic soda (by-product) \$675/t.
- Boric acid (by-product) \$710/t.

Taxes and Fees

- A federal tax rate of 21% on taxable income has been applied.
- A Utah state tax of 4.95% has been applied to taxable income.
- A disposal fee of \$0.15/barrel (159 L) is assessed for all spent brines returned through underground injection control (UIC) wells located on state land. This fee may be negotiated lower.
- Sales taxes on purchases have not been included in the costs (not included in previous PEA estimates).

Discounted Cash Flow

A discounted cash flow (DCF) was derived by estimating net revenues, subtracting the operating costs to yield the EBITDA, and then subtracting capital costs to arrive at a pre-tax DCF.

Taxes were calculated accounting for deductions, and then applied to yield a post-tax DCF. The project cash flows are summarized in Table 5 below.

PHASE	PRE-TAX (USD)		POST-TAX (USD)	
	NPV (7%)	IRR	NPV (7%)	IRR
Phase 1	\$650m	38%	\$468m	31%

Table 5: Paradox Brine Project Results of Economic Analysis

Mineral Resource Estimate

Historical data for the Paradox Brine Project area is more robust than many lithium exploration targets due to the Paradox Basin's long history of oil and gas production. Numerous well records and geophysical logs are readily available for the Project area. Furthermore, there is published historical data on the chemistry of brine fluids from a variety of horizons within the Paradox Formation, allowing for more precise targeting of prospective geologic horizons. However, historical assay data must be treated with caution as no original data records are available, and the first publication of this data is generally second hand.

The Mineral Resource estimate was calculated only for the brine aquifers of Clastic Zones 17, 19, 29, 31 and 33 within the Project area and indicates 192,000 tonnes of contained lithium carbonate equivalent (LCE); 1,176,000 tonnes of bromine and 1,517,000 tonnes of sodium bromide (NaBr). A summary table of JORC Compliant Mineral Resource Estimate is presented below in Table 6. Significant amounts of other minerals including Boron (Boric Acid, H₃BO₃) and Iodine (I₂) have also been estimated.

The average mean lithium concentrations range from 11ppm to 196ppm with a maximum recorded concentration of 253ppm. The bromine concentrations range from 2,240ppm to 3,705ppm with a maximum recorded concentration of 5,041ppm. Modelling of the Paradox Brine Project was performed with ARANZ Leapfrog modelling software using stratigraphic data from the 38 wells in the database. The model has been used to estimate recoverable brine within the project area using a static model and takes no account of pumping other than by the application of effective porosity. The 3D model also shows the extent of the clastic zones which contain the brine and are open in all directions, see Figure 1.

Category	Clastic Zone	Brine Tonnes (Mt)	Effective Porosity(%)	Li (ppm)	Br (ppm)	B (ppm)	I (ppm)	Contained ('000t) ¹		
								Li ₂ CO ₃	Br ₂	NaBr
Indicated	31	37	14.4	175	3,909	3,867	150	34	143	185
Inferred	31	74	16.4	172	2,987	3,056	154	68	221	285
Resource		111		173	3,292	3,324	153	102	364	470
Indicated	17,19,29,33	39	14	76	3,664	3,227	54	16	142	183
Inferred	17,19,29,33	191	14	73	3,510	3,113	51	74	670	864
Resource		230		74	3,537	3,132	51	90	812	1,047
TOTAL		341						192	1,176	1,517

Table 6: Paradox Brine Project Mineral Resource Estimate.

¹ Lithium is converted to lithium carbonate (Li₂CO₃) using a conversion factor of 5.32 and Br₂ to NaBr using a conversion factor of 1.29. Rounding errors may occur.

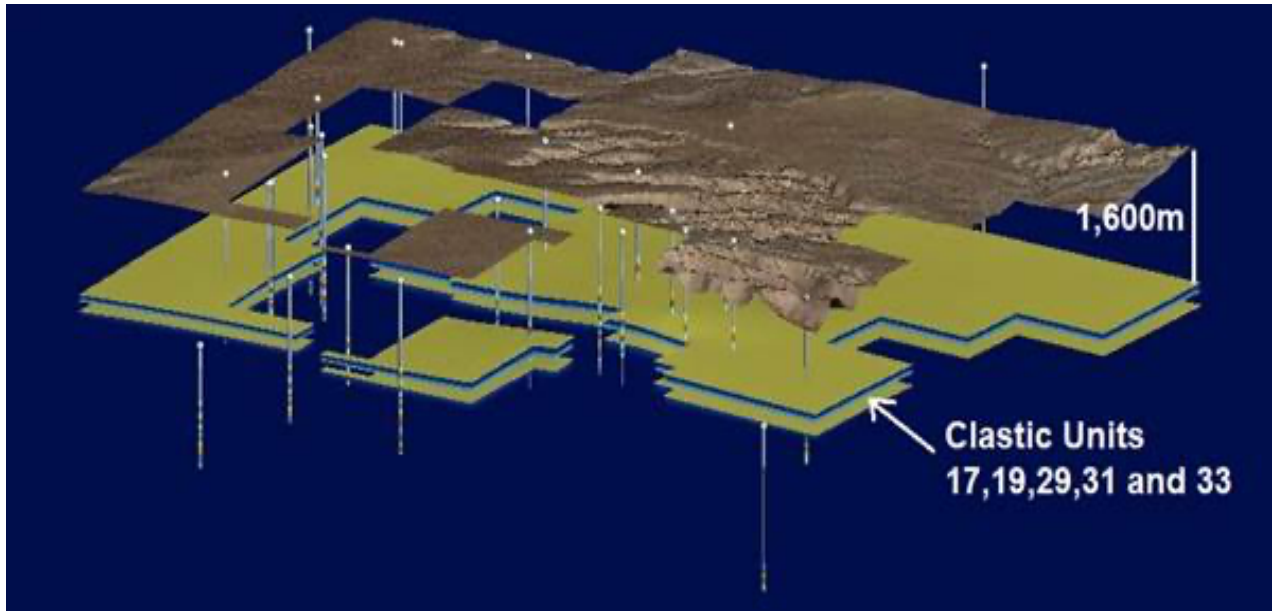

Figure 1: Paradox Brine Project View showing surface topography, wells and modelled clastic zones

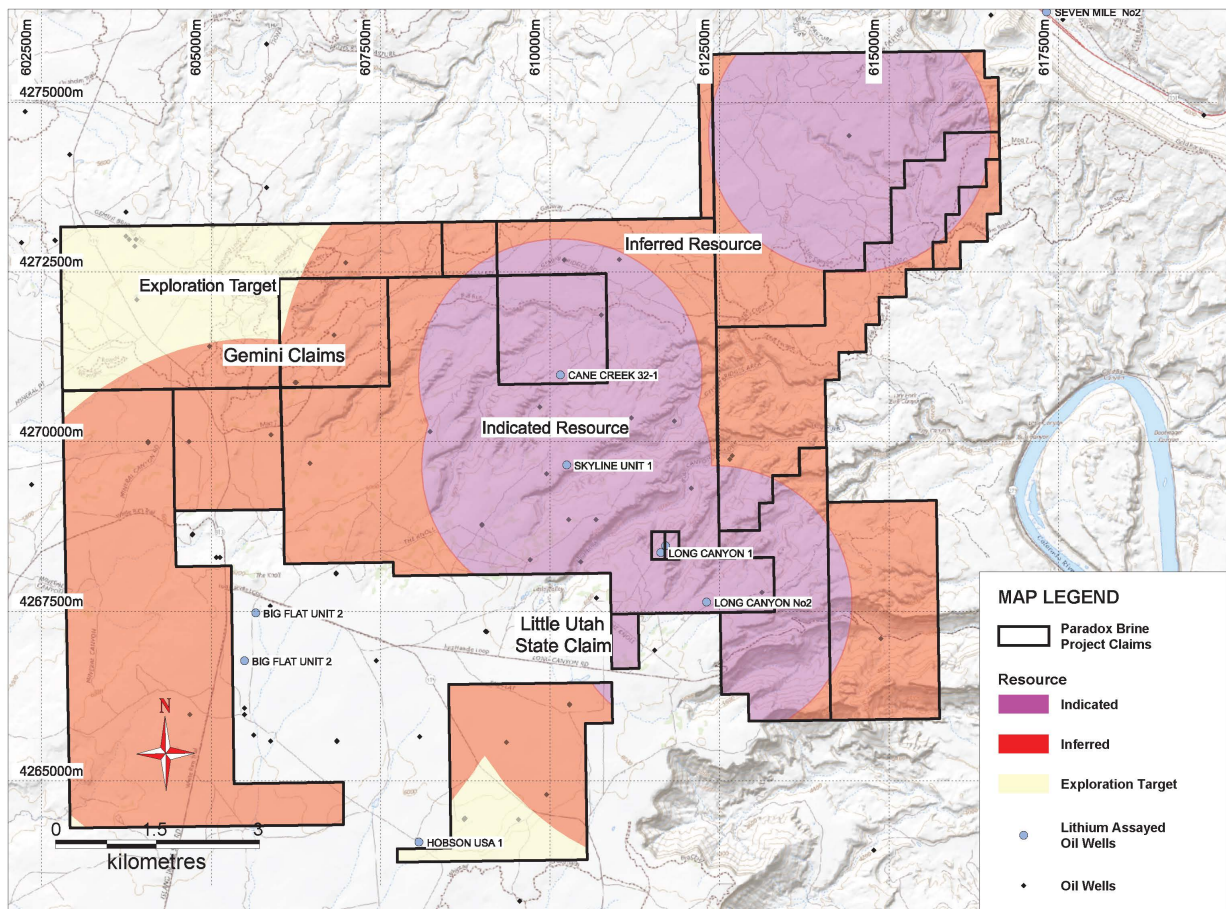

Figure 2: Plan showing the Resource classification for Clastic Zone 31.

The conceptual hydrogeological model for the brine aquifer has four extensively fractured geological units comprising of the following interbedded units (from top to bottom).

- Anhydrite;
- Black Shale;
- Dolomite; and
- Anhydrite

Anson has re-entered historic oil wells to depths of up to 2,300 metres in the Paradox Brine Project area. The wells have an average spacing of 1.6km (ranging between 1.3km and 3.0km). The bores have delineated an aquifer containing hyper-saline brine with total dissolved solids (TDS) ranging between 350,000 mg/L and 410,000 mg/L. The brine is enriched with respect to bromine, lithium and other recoverable minerals. The sampling of the supersaturated brines from the clastic zones of the Paradox Formation have yielded concentrations up to 5,041 ppm bromine and 253 ppm lithium.

The planned 20-year production is supported by the bromine and lithium which are in the Indicated category. The bromine extracted will then be processed into sodium bromide (NaBr) and the lithium will be extracted will then be processed into lithium carbonate (Li_2CO_3). To date the large exploration target for Clastic Zones 17, 19, 29 and 33, see Figure 3, is due to the fact that there are no historical assays or new drilling to extend the Indicated and Inferred Resources category estimates, which is not the case with Clastic Zone 31. With the addition of one re-entry, the Inferred Resource would probably be converted to the Indicated category in Clastic Zone 31 and the Exploration Target estimate to an Inferred category for the Clastic Zones 17, 19, 29 and 33. This would result in an increase in the block model tonnages and grades for the additional Clastic Zones as there has been no recorded assays in those locations. Assay data and effective porosity values in those areas would increase both the Indicated and Inferred Resource estimates.

This interpretation is based on the geological data collected in the exploration programs and the relevant historical data for the Paradox Basin which includes geophysical logs, core and cuttings for the oil well drilling which has been stored by the USGS.

The historical geophysical logs from the oil and gas wells of the Project area can be useful in characterising the brine aquifer formation. Of particular interest is the lithology of the brine aquifer, as well as formation porosity. Most of the clastic intervals within the Paradox Formation are a mix of anhydrite, shale, and dolomitic siltstone. These clastic intervals represent sea level highs, and the transition from transgressive to regressive phases. Intervening salt deposition occurred at sea level lows and the transition from regressive to transgressive sequences. These cycles can be readily identified in geophysical logs by combining interpretations of natural gamma and neutron density.

All the drilling programs completed by Anson have intersected hypersaline brines in all the clastic zone horizons sampled (CZ 17, 19, 29, 31 & 33). The clastic intervals are typically interbedded dolomite, dolomitic siltstone, anhydrite, and black shale. Clastic intervals typically range in thickness from 3 to 60 m. And are generally overlain by a salt sequence of 60 to 122 m. Within the project area, the evaporite section in the Paradox Formation ranges from 875 to 1165 meters in thickness. Potentially economic mineral-bearing brines are confined to the clastic intervals in Paradox Formation. Within the Paradox Basin, brines that host known bromine and lithium mineralization occur within the saline facies of the Paradox Formation. The saline facies consist of 29 identified evaporitic cycles.

The deposit model for the Paradox Basin is similar to brine deposits located in the Jurassic age Smackover Formation in Arkansas, USA. The Smackover Formation is predominantly made up of oolitic and silty limestones. Brines recovered from these wells supplies the vast majority of bromine produced in the U.S.

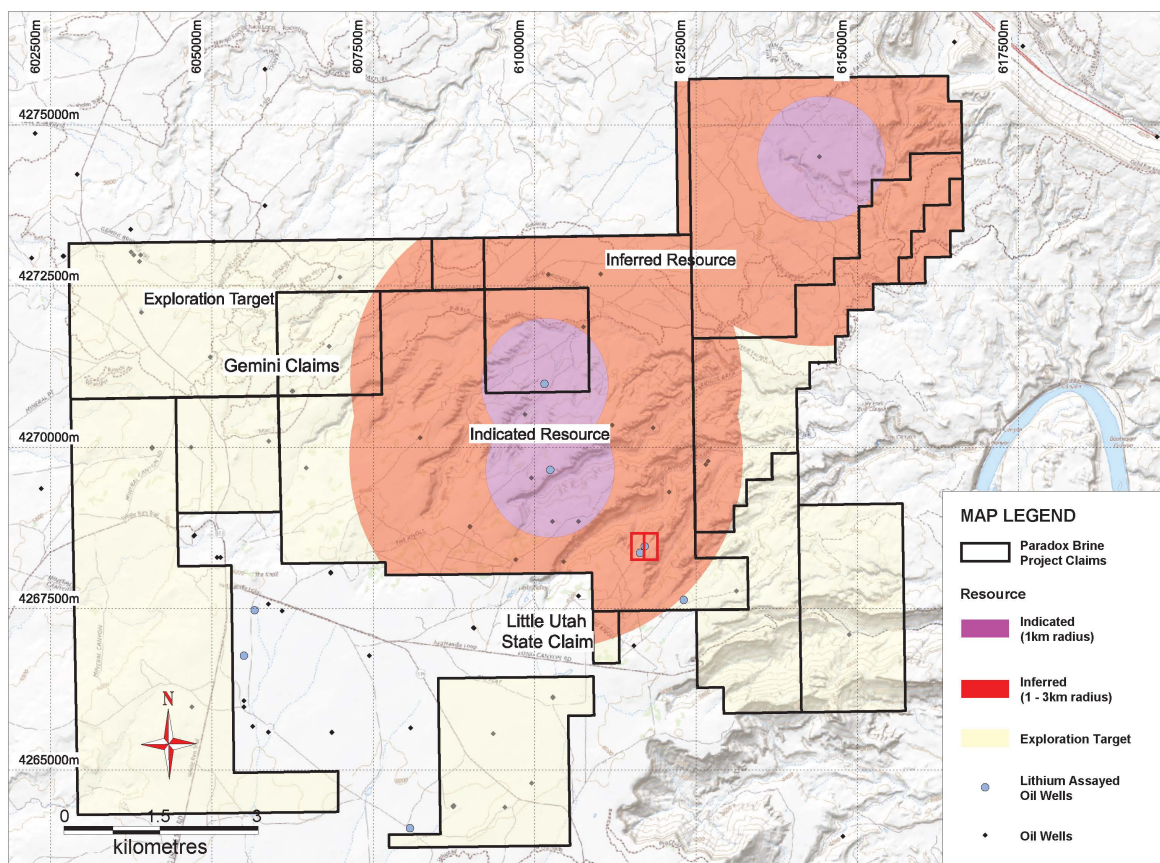

Figure 3: Plan showing the Resource classification for Clastic Zones 17, 19, 29 & 33.

Pumping tests have allowed determination of the hydraulic properties of this aquifer. Four separate flow tests have been completed at rates ranging between 3L/s and 12L/s, for periods of 4 to 12 hours. No pumping was required due to the artesian flow. Flow tests allowed determination of the aquifer permeability and associated potential parameters for brine-abstraction.

Spinner-flowmeter logging carried out on some re-entered wells show that the brine flows not just from the dolomite, but also from the anhydrite and shale units due to a secondary porosity.

Anson completed build-up tests to estimate production interval permeability with the data analysed to determine the formation permeability (from the Horner Plot). The analysis was carried out by reservoir engineers from Energy Operating Company, Inc and Hansen Petroleum.

The permeability's ranged from 1,698 to 6,543 millidarcies (mD). The permeabilities were calculated for the clastic zone as a whole, with no differentiation between shale and dolomite lithologies.

In general, the permeability increases with increasing effective porosity and decreases with increasing pressure. However, secondary porosity in the form of fracturing increases the bulk permeability of a geologic unit, as well as increasing its sensitivity to effective pressure.

The hydraulic conductivity for the Clastic Zone ranges from 0.02 to 0.07 m/d and the transmissivity ranges from 0.099 to 0.5 m²/d. The high relative transmissivities shown by the shale lithologies, as well as the high permeability's indicate that the flow system is complex with varying porosity of the dolomite and shale units, which are in turn dominated by secondary porosity related to fracturing.

This testing also indicates that lithological thickness vs. flow contribution for the shale unit has a higher transmissivity than the silty dolomite, which based on known textural differences, suggests significant secondary porosity (fracturing) within the shale.

Testing on samples such as the dolomite and black shale units were used to calculate a value for the Effective Porosity. Three separate techniques were used to determine the Effective Porosity, including High Pressure Mercury Injection (HPMI), Gas Transport Model Analysis (GTMA) and Scanning Electron Microscopy (SEM) analysis. This test work was carried out by Core Labs in the USA.

The effective porosity of the samples tested varied through the clastic zone based on the lithology from 4.1% to 21.3%. Typically, effective porosity is calculated from core laboratory analysis or through field testing. Effective porosity is an important parameter when assessing the mineral resource, as it is a measure of the interconnectedness of pores through which the brine would flow to production wells.

It should be noted that the Mineral Resource is a static estimate; it represents the volume of potentially recoverable brine that is contained within the defined aquifer taking into account the Effective Porosity. The Mineral Resource also takes no account of recharge to the aquifers within the clastic zones, which is a modifying factor that may increase brine-recovery from the units.

Production

Installation of a 15,000tpa NaBr and a 2,674tpa LCE production facility including all necessary equipment to produce a product plus primary reagents such as chlorine, hydrogen, and hydrochloric acid.

Production assumptions

Bore Field

The available field of wells both existing (to potentially be recompleted) and future is expansive. While initially, the brine assays provided presumed a subset of existing wells would be recompleted, over the course of the PEA, Anson elected to use as the basis 2 new well sites, Long Canyon Well #1 (LCW1) and Long Canyon #2 (LCW2) located on the Little Utah State claims recently granted by SITLA. The design on these wells has been completed as part of the NOI & Application for Permit to Drill (APD) to SITLA and DOGM

Pipelines

A ESG review of the project identified that the planned gathering lines from existing oil and gas wells to a major pipeline to be located in the existing gas pipeline corridor was expected to have an impact upon the environment with additional land clearing and pipeline Right of Ways (ROW's) to be established. In addition, as it was expected that the ROW's would have an impact on recreational activities in the area such as camping, bike riding and hiking, it was determined to minimise the impact on these activities by drilling new wells in close proximity to the existing pipeline corridor minimising new surface disturbance and transporting the brine to a production plant to an area where other value adding of resources already occurs.

In addition, an engineering study was conducted to take advantage of the "over-pressured" nature of the brine at the point of extraction. This study has identified the optimal diameter of the well to allow maximum amount of brine to flow to surface under its own pressure as well as provide sufficient pressure to allow the brine to flow to the planned production site without the need of additional pumping which was also identified in the ESG review. With no requirement to pump fuel emissions are avoided from both this activity as well as the transport of the energy resource to facilitate the pumping.

The pipeline to transport the brine to the planned production facility located 30 miles from the extraction wells will be 14" carbon steel pipe to keep the pressure rating reasonable and reduce

costs of additional wall thickness required to increase pressure rating. The internal wall of the carbon steel pipe will be lined with United Pipeline Systems TightLiner HDPE liner system to mitigate corrosion, decrease flow resistance, and provide additional containment in the event of external damage to the carbon steel pipe.

Pipelines will be installed as required using a combination of above-ground, buried via open-cut construction, or horizontal directional drilling (HDD) with an objective of reducing surface disturbance and impact on recreational activities.

An appropriate measure of protection of the pipeline material is considered – painting for above-ground pipe, fusion-bonded epoxy for open-cut construction, and an abrasion resistant overlay for HDD installed piping material.

Main Brine Pipeline

The main brine pipeline will be 14” carbon steel pipe to maintain flow/velocity and prevent flashing at the high point of the line.

The internal wall of the carbon steel pipe will be lined with United Pipeline Systems TightLiner HDPE liner system to mitigate corrosion, decrease flow resistance, and provide additional containment in the event of external damage to the carbon steel pipe.

The route for the main brine pipeline was established by collocating adjacent to the existing Deadhorse Point Lateral gas line. Most of the main brine pipeline will be installed above ground. However, like the gathering pipelines, the main brine pipeline will be installed as required using a combination of above-ground, buried via open-cut construction, or horizontal directional drilling (HDD). An appropriate measure of protection of the pipeline material is considered fusion-bonded epoxy for open-cut construction, and an abrasion resistant overlay for HDD installed piping material.

For personal use only

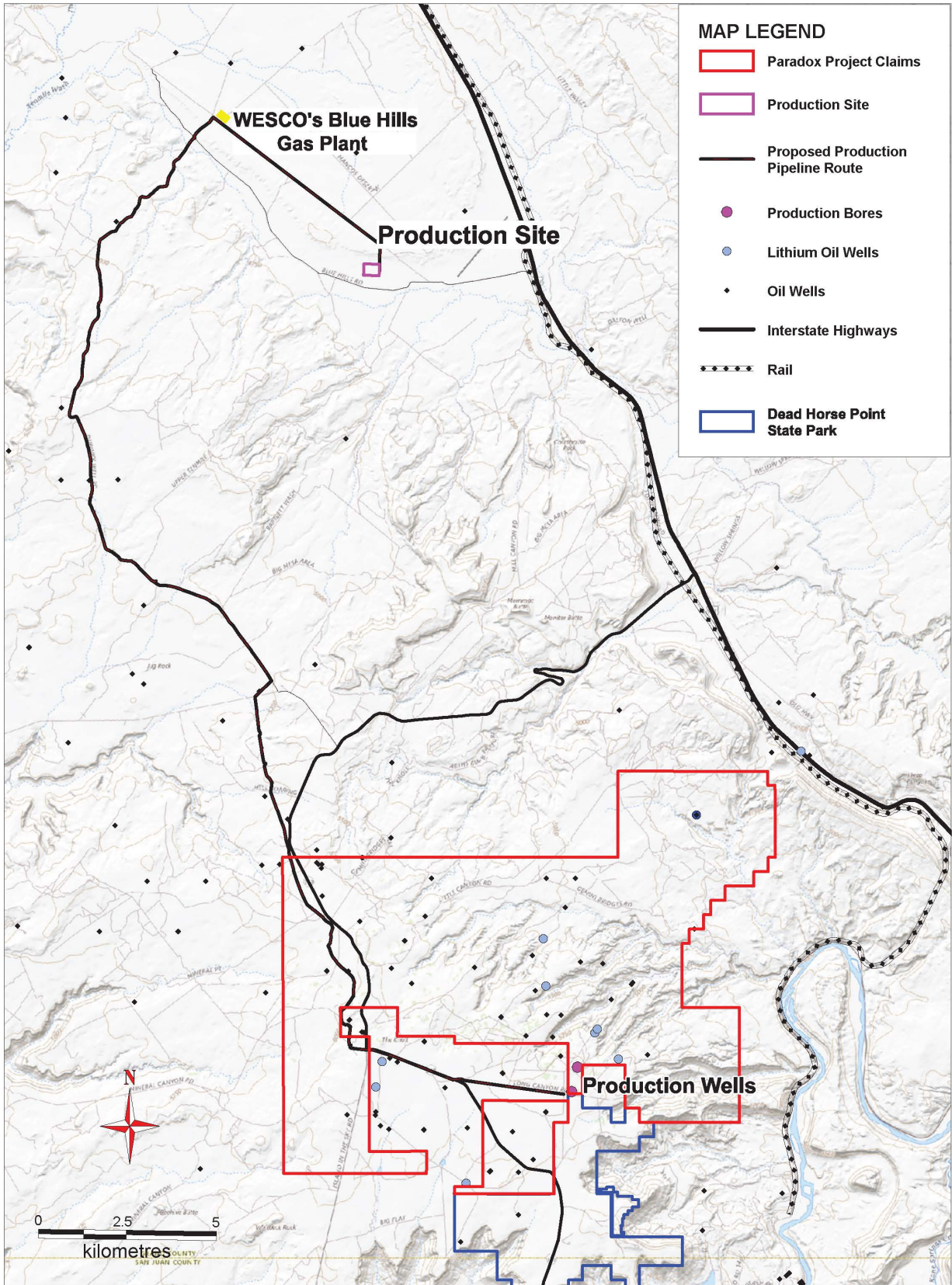

Figure 4: Paradox Brine Project Infrastructure.

Metallurgy and Laboratory Results

Aquifer parameters were determined by using three separate techniques to determine the Effective Porosity, including High Pressure Mercury Injection (HPMI), Gas Transport Model Analysis (GTMA) and Scanning Electron Microscopy (SEM) analysis. This test work was carried out by Core Labs in the USA.

Brine chemistry was undertaken by four different laboratories assaying for multiple elements utilising different methodologies. SGS utilized EPA 6010B (ICP-AES) for analysis of cations, and a variety of standard methods for analysis of anions. WETLAB completed density analysis, hydrocarbon analyses, and anions by ion chromatography (EPA Method 300.0) for bromide, chloride, fluoride, and sulphate. WETLAB then subcontracted out the analysis for bromine (via Schoniger Combustion) to Midwest Microlab of Indianapolis, Indiana, and total metals by inductively coupled plasma – atomic emission spectrometry (ICP-AES) (EPA Method 200.7) for lithium, boron, and magnesium were subcontracted to Asset Laboratories of Las Vegas, Nevada. – all in Analytica

Geotechnical Survey of Plant Location

A geotechnical survey of the plant location has been conducted by an independent engineering company that specialises in this field. The report that was produced provided results of the geotechnical engineering investigation and foundation recommendations for the design and construction of the planned production plant. These results were factored into the estimated costs for this PEA study.

Natural Gas

A natural Gas pipeline that passes within 500m of the planned production plant has recently been purchased by a Utah gas provider. This gas pipeline is connected to a larger gas pipeline network which is owned by a second gas company which is able to provide gas from Texas to Canada providing the opportunity to negotiate the gas price. Discussions are underway with owners of the both of these pipelines for the delivery of natural gas to the planned production facility. The cost of gas in the PEA is based upon historical known gas prices in the area.

Electricity

Power to the new facility will be provided from a new 138kV transmission line installed from an existing utility transmission line within 1 mile of the facility. A new substation will be installed to step the 138kV power down to 13.8kV power for distribution throughout the site. As required, transformers will be installed at each unit to provide voltages necessary to operate the equipment in each area.

A stand-by natural gas generator will be installed at the bromine unit to provide stand-by power if utility power is lost. Stand-by power is sized to provide safe shutdown of the chemical processing equipment and a secure environment and site egress for employees (~6% of connected load).

Power for the new facility will be provided by the local utility, Rocky Mountain Power (RMP), from an existing 138kV transmission line within a mile of the new facility. At this utility interconnect, a new switchyard and metering station will be installed. A number of studies have been completed by RMP on behalf of the Company to accurately assess the cost of any powerline upgrades that are required to ensure stable supply of electricity to the planned production facility. The estimated costs generated by these studies have been included in the PEA financial estimates.

A new 138kV transmission line using H-frame structures will deliver power to a new High Voltage (HV) substation on the site. The substation will include a dead-end structure, and single 15MVA 138 – 13.8kV substation transformer with primary and secondary circuit breaker protection.

Water

Brine will be used as the source of water for the needs of the plant. The brine, as it leaves the bromine plant process, will be treated and used to produce plant water, cooling water, chilled water, fire water, boiler feed water, demineralized water and potable water. Commercially available reverse osmosis (RO) system as the basis for primary water treatment was considered. However, RO proved inadequate for cleaning the brine stream due to the high level of dissolved solids.

For dealing with the high level of dissolved solids, an alternate technology known as Mechanical Vapor Recompression (MVR) was qualified and selected.

Spent Brine Disposal

Effluents being very close to the chemical composition of the brine that originally came out of the ground will be re-injected into the ground without additional treatment within the plant battery limits.

Spent brine will be disposed back into the lower Paradox Formation through underground injection control (UIC) wells. A1 Lithium will be initiating permitting for Class V-1c UIC wells with the Utah Division of Water Quality which will allow injection of spent brines back into the formation they originate. Spent brine will essentially have the same characteristics as before processing minus bromine, lithium, and some of the other transition metals captured through filtration. The processing facility site can accommodate two to three UIC wells.

The effluent brine will be disposed of in the same formation from which it will be extracted but not in the same clastic horizons from which it is planned to be extracted. Geological studies have identified that the targeted formation is closer to surface nearby the planned production well than from where it is extracted due to the presence of a fault and as a result the pressure is lower than the extraction wells.

Process Design and Description

The bromine process is well understood and is based on traditional chemical processing. The bromine product will then be used in the production of sodium bromide. The Paradox Brine Project process flowsheet for bromine production is shown in Figure 6.

Bromine Recovery

The bromine recovery plant is using the Kubierschky process. In the Reaction Columns bromide is oxidized to elementary bromine with chlorine and stripped off from the brine. The oxidation occurs under acidic conditions (pH 2-3).

The feed brine is split into two streams. Main part of the brine is pumped to feed preheater / effluent cooler. The other part of the brine is utilized in the Vent Scrubber to wash the vent gas from the plant.

The cold brine from the Vent Scrubber and the preheated feed are fed to the top of the Reaction Columns. There, the bromide is oxidized to bromine with chlorine. The efficiency of the reaction is estimated to reach 90%. Bromine and any excess chlorine are stripped out by live steam fed into the bottom of the column.

The vapor from the top of Reaction Column is cooled down in the Condensers to condense bromine and the steam excess. The condensate flows to the Bromine Separator where it is separated into a heavy bromine phase saturated with water, containing parts of the surplus chlorine and an aqueous phase, saturated with bromine and a small amount of solute chlorine. The aqueous phase from Bromine Separator is fed back into Reaction Column via free gravity flow. The bromine phase is transferred the Purification Column and then to a day tank before transfer to the NaBr conversion process.

The vent off-gas is sub-cooled in the condenser. Any excess of chlorine from the process and bromine according to partial pressure leave the condenser to the Vent Scrubber. The condensate from the Condenser is fed to the Bromine Separator.

Sodium Bromide Production

The purified liquid bromine stream is fed to the Sodium Bromide Reactor Column where it is reacted with caustic and hydrogen peroxide to produce an approximately 43% NaBr solution for sale. The caustic is supplied from the Chlor-Alkali Plant and hydrogen peroxide is delivered from off-site by truck.

The produced sodium bromide is inventoried in one of two storage tanks prior to truck loading for sale to the market.

Chlor-Alkali Unit

The chlor-alkali plant produces chlorine, caustic soda and hydrochloric acid. The plant sizing is such that all the produced chlorine is consumed within the facility. Caustic that is surplus to the facility's requirements is sold as 32% NaOH.

Salt from nearby Intrepid Potash is used as the feedstock to the chlor-alkali plant. It is purified before use in the electrolyzers where chlorine, caustic and hydrogen are produced. A portion of the chlorine and hydrogen are reacted to produce hydrochloric acid solution. The split between chlorine production and HCl production is dictated by the De Dietrich chlorination and acidification requirements. Caustic is predominately used by De Dietrich to produce the NaBr.

In addition to salt the chlor-alkali plant requires carbon dioxide, nitrogen and hydrogen peroxide for various unit operations within the plant. The consumption of these chemicals is considered in the operating cost calculation.

The balance of the plant requirements such as utilities and power are supplied to the chlor-alkali plant from the common facilities.

Exhaust Air Treatment

All exhaust air streams from the plant, containing chlorine and bromine are collected and fed to the bottom of a vent scrubber. Passing the column in counter-current flow with a part of the feed brine, bromine is absorbed, and chlorine oxidizes bromide to bromine. The solution leaving the scrubber is fed to the top of the Reaction Columns. Residual bromine and chlorine in the exhaust air from vent scrubber is fed to a caustic scrubber for final scrubbing before venting to the atmosphere.

Summary

De Dietrich Process Systems GmbH (De Dietrich) successfully completed test work to extract bromine from the Paradox Project brine, which resulted in a recovery of 90%. The test work was conducted in De Dietrich's bromine pilot plant in Germany and validates the first stage test work conducted in laboratory scale equipment.

The conventional bromine extraction process has five parts:

- Oxidation of the brine using chlorine gas to convert dissolved bromide ions into dissolved bromine liquid;
- Heating of the brine to 60-80°C to accelerate the evaporation of the bromine, taking it from being part of the brine to being in the gas phase which can be separated easily;
- Condensation of the bromine in gas phase to bromine in liquid phase;
- Scrubbing of the bromine to remove trace chlorine gas; and
- Scrubbing of the bromine to remove trace water.

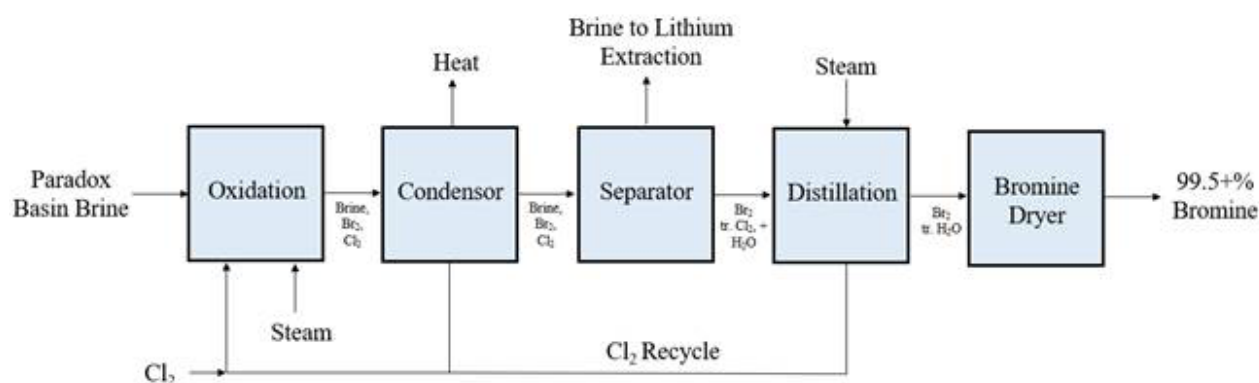

Figure 5: Paradox Brine Project Bromine Production Flowsheet

Lithium Plant

The lithium plant will use a Direct Lithium Extraction (“DLE”) processes to remove lithium from brines while leaving other components in the brine.

The initial benchtop test work was carried out in February 2021 on 50 litres of previously extracted Clastic Zone 31 brine from the Long Canyon No. 2 well. Upon confirmation that the process worked, Anson repeated the testing on a small-scale pilot plant test using 4,000 litres of freshly extracted brine from Clastic Zone 31 of the Long Canyon No. 2 well. The average head grade for the 4,000 litres brine was tested to be 200ppm Li (see ASX announcement 13 August 2021).

A total of 126 barrels (20,000 litres) was then extracted from the well. Four totes (approximately 4,000 litres) were filled for DLE extraction test work at a laboratory in Utah and an additional 40 litres provided to TETRA for test work. The remaining approximately 16,000 litres of brine were transported by tanker into storage tanks previously installed by Anson at the Cane Creek 32-1 well site, (see ASX Announcement 4 February 2019).

Following extraction via DLE, the mother liquor produced from the DLE process is then evaporated to the crystallization point to produce lithium hydroxide monohydrate and concentrated then contacted with carbon dioxide to product lithium carbonate. The precipitated lithium carbonate is then dried, sized and packaged for sale.

Anson has produced both lithium carbonate and lithium hydroxide from its Paradox Project brine to the required battery grade specifications in bench top/pilot plant test work. The lithium test work involved the following steps:

- A bulk brine sample was extracted from Anson’s Paradox Brine Project;
- The bulk sample was processed off site using direct lithium extraction technology to produce lithium chloride;
- Lithium chloride was concentrated;
- Lithium hydroxide solution and chlorine gas were produced using electrolysis eliminating the traditional intermediate step of first producing lithium carbonate before producing lithium hydroxide;
- Two products were produced from the lithium hydroxide solution:
 - battery quality lithium carbonate; and
 - battery grade lithium hydroxide monohydrate using Veolia’s two stage patented production process, the “HPD evaporation and crystallization technology”.

Project Flowsheet

The flow sheet below shows the project producing both NaBr and Li₂CO₃. Significantly, the chlorine that will be produced from the electrolysis process will be fed into the

bromine extraction process negating the need to purchase chlorine as part of the bromine production process. Some of the chlorine that is produced will also be converted to hydrochloric acid (HCl) for use in both the bromine and lithium extraction processes.

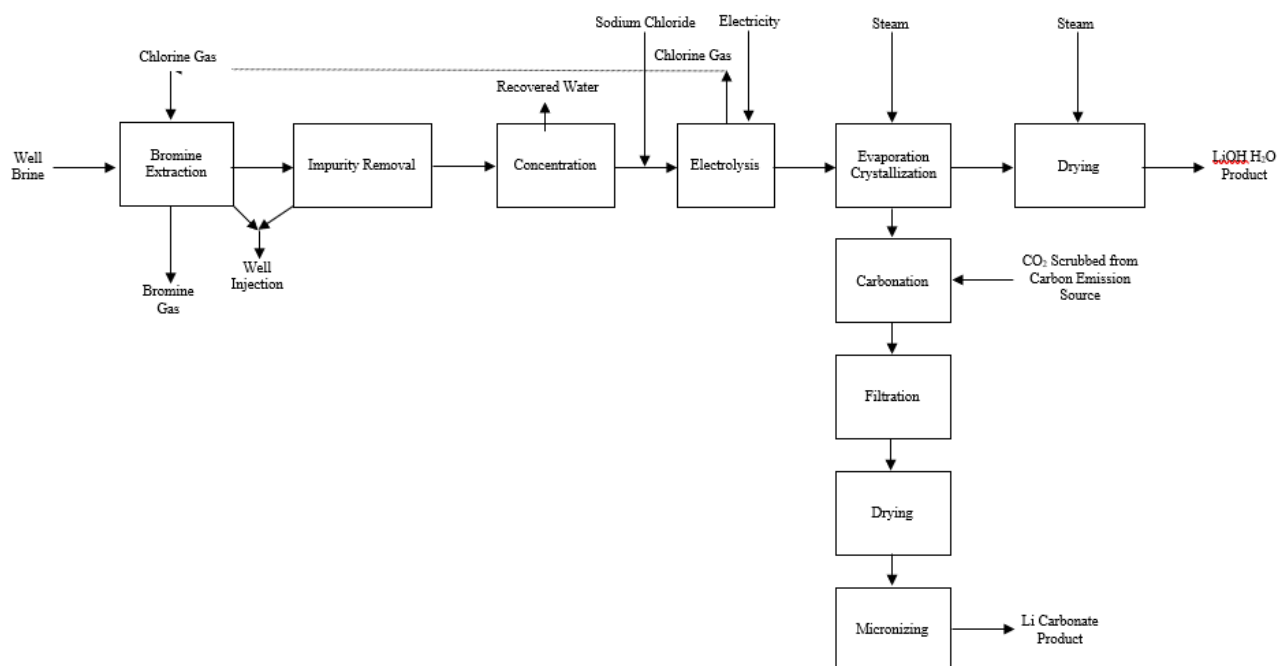

Figure 6: Paradox Brine Project Phase 1 Flowsheet

Infrastructure

The Paradox Brine Project is located in close proximity to all existing major utilities and transportation infrastructure, see Figure 7. The utilities include natural gas pipelines and high voltage powerlines which pass close to the production site and will be used in the production facility. In addition, there are interstate highways and a rail link suitable for transporting the sodium bromide and lithium carbonate products.

Graded county roads will be used to access the wells planned for re-entry and are currently accessible by pick-up trucks but will require some grading and minor maintenance for continuous use once production begins. The processing plant will be serviced by a 320 m road that connects the site to County Road 138.

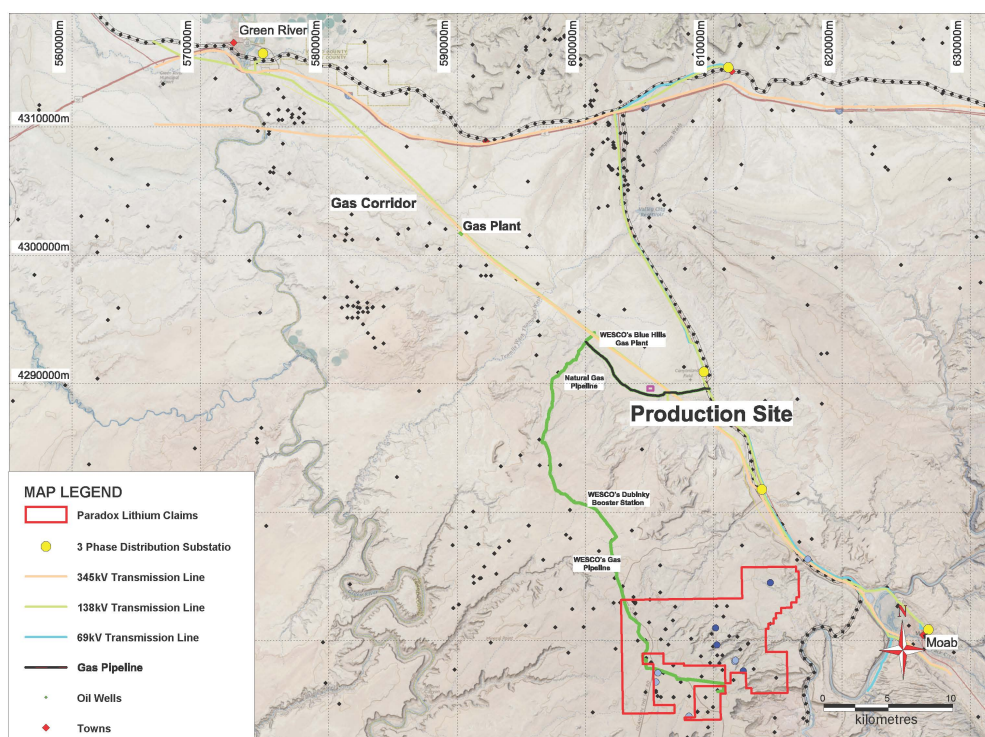

Figure 7: Plan showing the regional infrastructure in close proximity to Paradox Brine Project.

Following processing and recovery of bromine and lithium, spent brine will be disposed back into the lower Paradox Formation through underground injection control (UIC) wells. Spent brine will essentially have the same characteristics as before processing minus bromine, lithium, and some of the other transition metals captured through filtration.

Capital Costs

The capital cost estimate is accurate to within +/- 50% and includes costs for mechanical equipment and installation, electrical and instrumentation, structural steel materials and installation, platework materials and installation, and foundation materials and installation.

This includes a 15,000tpa NaBr and 2,674tpa Li_2CO_3 production facility, which includes all necessary equipment to produce NaBr plus primary reagents such as chlorine, hydrogen and hydrochloric acid (HCl), and excluded wells which are part of the exploration programme. Capital costs are summarized below:

- NaBr plant (labour, equipment and materials) – US\$71m
- NaBr plant (components and modules) – US\$68m
- NaBr plant (engineering) - US\$9m
- Lithium plant (EPC) – US\$55m

Operating Costs

The process design of the NaBr and LCE facility includes the equipment and process required to produce the primary reagents required for production. The primary reagents of Chlorine (Cl) wet gas, NaOH, and HCl will be produced in sufficient quantities to feed the Phase 1 of the project with excess NaOH being sold as a by-product. Costs are summarized below.

- Raw Materials Cost - \$11.4m per year
- Utilities Cost - \$6.9m per year

- Operating Labour Cost - \$5.9m per year
- Spent brine disposal - \$2.7m per year
- Maintenance parts and supplies - \$2.3m per year
- Contingency (15%) - \$2.8m per year

Product Pricing

Bromine

The global bromine market was valued at US\$3.3 billion in 2019 and is projected to grow at a compound annual growth rate (CAGR) of 5.8% to reach US\$4.4 billion by 2024. The demand for bromine was not impacted by COVID-19 and the forecast CAGR of 5.8% remains unchanged (Markets and Markets). Additional market research indicates a further increase to USD6.6 billion in 2027 (ResearchandMarkets.com). In terms of volume, approximately 740 kilotons were produced in 2019 and is expected to rise to an estimated 880 kilotons in 2024.

The largest application for bromine-based compounds is in the production of brominated flame retardants (BFRs), accounting for 37% (100% bromine content) of total global consumption. The flame-retardant market is affected by regulations in two countervailing ways. First, there are international, regional, and national fire safety regulations and flammability standards for flame retardants that are used in the construction, transportation, and electrical and electronics industries. Second, government regulations also affect individual chemical types that are deemed to have deleterious effects on the environment and human health.

Clear brine fluids (CBFs) constitute the second-largest end-use market, accounting for 17% of global consumption of bromine-based compounds, a majority of which is used in North America. CBFs are used to enhance drilling fluids used for the production of crude oil in deep, high-pressure wells where conventional drilling muds can plug the formations. There is also increased use for the development of nonconventional sources such as deep-water wells and oil sands.

Water treatment accounts for approximately 8% of the global consumption of bromine-based compounds. The majority is consumed in China and the United States, with a smaller amount consumed in Western Europe. Products used in this segment are brominated hydantoins and sodium/ammonium bromides. Consumption is broken down nearly equally between hydantoins and bromides.

Consumption of hydrogen bromide (HBr) used as a catalyst in the production of purified terephthalic acid (TPA) accounts for nearly 12% of global consumption of bromine-based compounds. TPA is used in polyethylene terephthalate (PET) production; PET is ultimately used in packaging and fibres. HBr is also being used in flow batteries in the electricity and electronics industry.

Other applications include use in pharmaceuticals, agricultural/pesticides, dyes, and lithium bromide for use in absorption chillers. Bromine based product to disinfect public spaces to reduce the spread of COVID-19 experienced significant increase in sales over the past twelve months.

The average price for purified, bulk 99.95% bromine in 2017 on an ex-works U.S. basis, as reported by Markets and Markets, was US\$4,830/t. Prices have steadily increased 4.5% through 2019 to an average price of US\$5,050/t. 2022 to 2028 to forecast the prices based upon the CAGR of 10.5% and 7.1% then we have a total market value for CBF's of \$330.06 million and market size of 48,500t. Dividing \$/t, the price in 6 years would rise to USD6,867/t. Actual prices for bromine and bromine derivatives are negotiated on long-term and short-term contracts between buyers and sellers.

The PEA has utilised the forward price of US\$5,280/t over all years of production.

Anson is confident of being able to achieve the above stated bromine prices as a result of the successful test work previously performed by De Dietrich Process Systems GmbH. De Dietrich successfully completed test work to extract bromine from the Paradox Project brine, which resulted

in a recovery of 90%. The test work was conducted in De Dietrich's bromine pilot plant in Germany and validates the first stage test work conducted in laboratory scale equipment. The pilot plant used the well-known and understood "Kubierschky Process" for the extraction and recovery of bromine. (Refer announcement of 20 December 2019 titled "*Anson Bromine Piloting Successful*").

Lithium

Global end-use markets for Lithium are estimated as follows: batteries, 65%; ceramics and glass, 18%; lubricating greases, 5%; polymer production, 3%; continuous casting mould flux powders, 3%; air treatment, 1%; and other uses, 5%. Lithium consumption significantly increased between 2014 and 2017 due to a strong demand for rechargeable lithium batteries used extensively in portable electronic devices, electric tools, electric vehicles, and grid storage applications. Lithium minerals were used directly as ore concentrates in ceramics and glass applications.

In 2017, prices had been propelled through successive multi year highs by strong demand from the lithium-ion battery industry set against a backdrop of uncertainty over future supply. This attracted significant attention on the lithium sector and incentivised investment into both mining and processing capacity. Prices for all lithium products subsequently fell as production at operations in China, Australia, Canada and Chile ramped-up, and as a swath of greenfield projects mitigated fears of future supply shortages.

Average annual lithium carbonate prices in 2016 were US\$8,650/t. Lithium carbonate prices peaked in November 2017 at US\$25,800/t and at the start of 2020 were at US\$8,750. As reported in Seeking Alpha, Benchmark Mineral Intelligence believes oversupply in lithium carbonate is expected to peak in 2020 and predicted to be at US\$12,000 by the end of the year. The price is expected to grow at a CAGR of 2% reaching a price of US\$13,000 by 2025.

The PEA has utilised the forward price of US\$15,000/t over all years of production as commercial production is expected to be in year 5 which is within the forecast period. This is considered conservative given the expected growth in the market driven among other things by increased demand for lithium-ion batteries.

Anson is confident of being able to achieve the above stated lithium carbonate prices as a result of having produced a bulk sample of battery grade 99.9% lithium carbonate (Refer announcement of 12 December 2019 titled "*Anson Produces Lithium Carbonate Bulk Sample*").

Anson produced both lithium carbonate and lithium hydroxide from its Paradox Project brine to the required battery grade specifications in bench top/pilot plant test work. Two products were produced from the lithium hydroxide solution:

- battery quality lithium carbonate (99.9%); and
- battery grade lithium hydroxide monohydrate (56.2%) using Veolia Water Technologies Inc's (Veolia) two stage patented production process, the "HPD evaporation and crystallization technology".

No deleterious elements were detected in the materials produced.

Project development funding

Anson believes that there are reasonable grounds to assume that future funding will be available for commencing the next stages of development including in the near term. Anson has a number of funding options through equity, debt, offtake agreements and strategic investment to fund the development of the project which are under active consideration.

Anson is confident on the following basis:

- Anson's Board has a financing track record which includes raising approx. A\$14 million over the last 3 years to advance the Paradox Brine Project. Anson has been able to raise this funding as required to advance the project to this stage and expects this to continue. In addition, Bruce Richardson, Executive Chairman and CEO has a proven track record of

over ten years in exploration, mining and production in public and private companies, and over 30 years of international business experience. He has raised over A\$170 million of investment in mining projects.

- Anson is confident that it can continue the development strategy at the Paradox Brine Project based on its current progress to date and exceptional results obtained from the PEA. Anson is based in Australia, with significant sources of equity and debt capital and very active resource focused capital markets. Anson has recently completed a capital raisings through brokers and the company considers that further equity funding can be obtained to partly finance the development of the first phase of the project.
- Anson has an existing A\$15 million Equity Placement Facility with Long State Investments Limited. This agreement was signed on the 10th of May 2019 and expires in on the 9th of May 2021 (see announcement titled “*Anson Closes SPP and Secures \$15m Equity Facility*” released on 20 May 2019). The balance of this facility is A\$14,750,000. This facility is considered as basis of further capital raisings and demonstrates Anson’s ability to finance the project through equity placement from investors or through debt capital from financiers in the United States of America where the project is located.
- The Company has been approached and is in discussion with a number of potential funders and intermediaries at a level commensurate with the current stage of the project. These include debt financing, traditional bank resource Project funding, offtake funding, Project and Corporate level equity investment and equipment finance providers. These discussions are continuing.
- The Company recognises that having robust offtake arrangements is an important factor in securing project finance and is actively engaged with potential partners to progress discussions with respect to offtake. Discussions with potential off-take partners regarding joint-venture, farm-in, off-take agreements and other funding structures related to its phase 1 bromine production have commenced and are continuing. These discussions provide Anson with the confidence that funding will be able to be secured for the project.
- Anson’s major investor Chia Tai Xinye Industrial Development Pte (Chia Tai) registered in Singapore has invested approximately A\$6.5 million in the Company for the development of the Paradox Brine Project. This investment has been through a number of placements and more recently a convertible note. Chia Tai has expressed interest in continuing to invest in Anson as evidenced by the options for further funding (US\$1.5m) contained with the convertible note which could not be exercised as a result of the recent changes to the *Foreign Acquisitions and Takeovers Act 1975 (Cth)*. Chia Tai provides another potential source of funds for the advancement of the project from Asia. Chia Tai is one of seven overseas business units of The Zhongfan Group Co. Ltd (Zhongfan). Zhongfan is a large-scale transnational enterprise group which integrates resource investment & development, trade, new materials technological development and manufacturing. It is privately owned and also has investments in the electronics and medical equipment industries. Its head office is in Shanghai. The Zhongfan Group also has a trading company based in Hong Kong which has an extensive distribution network for the trading of minerals.

- In recent years there has been continued investment in bromine production around the world as the market has continued to grow. Lanxess Chemical in 2018 announced an investment of Euro 200 million to increase its production of bromine-based fire retardants. Israel Chemical Ltd announced in 2019 that it planned to invest US\$110 million to increase production to 25,000tpa and smaller bromine producers such as Gulf Resources Inc has in 2017 million advised that it planned to invest US\$35 million in its production facilities in China. Tosoh Corporation (Japan) in its 2019 strategic plan announced that it was investing in bromine and bromine-based fire-retardant production while other private companies in India are continuing to raise money to invest in bromine production such as NIRMA Group which doubled its production capacity in 2019 to 7,300tpa. As such there is evidence of a growing market and funding available for bromine market projects.
- The forecast of a rising bromine price in the medium term provides the Company with confidence that funding will be able to be secured for all phases of the project.
- Anson is also able to consider other methods of value realisation to assist funding the project both in the short term and long term up to, such as a partial sale of the asset, long term offtake and joint venture agreements.
- The strong production and economic outcomes delivered by the PEA are considered by the Board to be sufficiently robust to provide confidence in Anson's ability to fund pre-production capital through conventional debt and equity financing. Anson has engaged with various international groups for strategic investments and off-take arrangements and to date these interactions have been positive.
- This has informed Anson's view of being able to secure the necessary funding for all phases of the project at times where the interest in financing these projects is expected to be high due to rising prices and market demand.

To achieve the range of proposed feasibility studies and potential mine development outcomes indicated in the PEA, additional funding will be required. Investors should note that there is no certainty that Anson will be able to raise funding when needed. It is also possible that such funding may only be available on terms that may be dilutive to or otherwise affect the value of Anson's existing shares, or include debt funding (and consequent gearing). It is also possible that Anson could pursue other value realisation strategies such as a sale, partial sale or joint venture of the project. If it does, this could materially reduce Anson's proportionate ownership of the project.

Project timetable

The project will require approximately 3 years of permitting, detailed engineering, and construction prior to the commissioning and operations of Phase 1.

Assumptions

The following assumptions were built into the project's timeline:

The PEA will build from the PEA to further refine resources, engineering, and design of the processing facility:

- The PoO work will not trigger the requirements for an Environmental Impact Statement.

- Baseline data necessary for the PoO process can be collected during one survey cycle and will not carry over into multiple years.
- The Project will not trigger the requirements for a major source air permit.

This announcement has been authorised for release by the Executive Chairman and CEO.

ENDS

For further information please contact:

Bruce Richardson
Executive Chairman and CEO

E: info@ansonresources.com

www.ansonresources.com

Ph: +61 8 478 491 355

Follow us on Twitter [@anson_ir](https://twitter.com/anson_ir)

Forward Looking Statements: Statements regarding plans with respect to Anson's mineral projects are forward looking statements. There can be no assurance that Anson's plans for development of its projects will proceed as expected and there can be no assurance that Anson will be able to confirm the presence of mineral deposits, that mineralisation may prove to be economic or that a project will be developed.

Competent Person's Statement 1: The information in this announcement that relates to exploration results and geology is based on information compiled and/or reviewed by Mr Greg Knox, a member in good standing of the Australasian Institute of Mining and Metallurgy. Mr Knox is a geologist who has sufficient experience which is relevant to the style of mineralisation under consideration and to the activity being undertaken to qualify as a "Competent Person", as defined in the 2012 Edition of the Australasian Code for Reporting of Exploration Results, Mineral Resources and Ore Reserves and consents to the inclusion in this report of the matters based on information in the form and context in which they appear. Mr Knox is a director of Anson and a consultant to Anson.

Competent Person's Statement 2: The information contained in this ASX release relating to Exploration Results and Mineral Resource Estimates has been prepared by Mr Richard Maddocks, MSc in Mineral Economics, BSc in Geology and Grad Dip in Applied Finance. Mr Maddocks is a Fellow of the Australasian Institute of Mining and Metallurgy (111714) with over 30 years of experience. Mr Maddocks has sufficient experience that is relevant to the style of mineralisation and type of deposit under consideration and to the activity being undertaken to qualify as a competent person as defined in the 2012 edition of the Australasian Code for Reporting of Exploration Results, Mineral Resources and Ore Reserves.

Mr Maddocks is an independent consultant to Anson Resources Ltd. Mr Maddocks consents to the inclusion in this announcement of this information in the form and context in which it appears. The information in this announcement is an accurate representation of the available data from exploration at the Paradox Brine Project.

Information is extracted from reports entitled 'Anson Obtains a Lithium Grade of 235ppm at Long Canyon No 2' created on 1 April 2019, 'Anson Estimates Exploration Target For Additional Zones' created on 12 June 2019, 'Anson Estimates Maiden JORC Mineral Resource' created on 17 June 2019, 'Anson Re-enters Skyline Well to Increase Br-Li Resource' created on 19 September 2019, 'Anson Confirms Li, Br for Additional Clastic Zones' created on 23 October 2019 and all are available to view on the ASX website under the ticker code ASN. Anson confirms that it is not aware of any new information or data that materially affects the information included in the original market announcement and, in the case of estimates of Mineral

Resources or Ore Reserves, that all material assumptions and technical parameters underpinning the estimates in the relevant market announcement continue to apply and have not materially changed. Anson confirms that the form and context in which the Competent Person's findings are presented have not been materially modified from the original market announcement.

For personal use only

JORC CODE 2012 “TABLE 1” REPORT

Section 1 Sampling Techniques and Data

(Criteria in this section apply to all succeeding sections.)

Criteria	JORC Code Explanation	Commentary
Sampling techniques	<ul style="list-style-type: none"> Nature and quality of sampling (e.g. cut channels, random chips, or specific specialized industry standard measurement tools appropriate to the minerals under investigation, such as down hole gamma sondes, or handheld XRF instruments, etc.). These examples should not be taken as limiting the broad meaning of sampling. Include reference to measures taken to ensure sample representivity and the appropriate calibration of any measurement tools or systems used. Aspects of the determination of mineralization that are Material to the Public Report. In cases where 'industry standard' work has been done this would be relatively simple (e.g. 'reverse circulation drilling was used to obtain 1 m samples from which 3 kg was pulverized to produce a 30 g charge for fire assay'). In other cases more explanation may be required, such as where there is coarse gold that has inherent sampling problems. Unusual commodities or mineralization types (e.g. submarine nodules) may warrant disclosure of detailed information. 	<ul style="list-style-type: none"> Historical oil wells (Gold Bar Unit #2, Cane Creek #32-1-25-20, Skyline Unit 1, and Long Canyon Unit 2) were utilized to access brine bearing horizons for sampling. Geophysical logging was completed to determine geologic relationships and guide casing perforation. Once perforated, a downhole packer system was utilized to isolate individual clastic zones (production intervals) for sampling. Perforation and packer isolated sampling moved from bottom to top to allow for the use of a single element packer. Brine fluid samples were discharged from each sample interval to large 1,000 L plastic totes. Samples were drawn from these totes to provide representative samples of the complete volume sampled at each production interval. The brine samples were collected in clean plastic bottles. Each bottle was marked with the location, sample interval, date and time of collection.
Drilling Techniques	<ul style="list-style-type: none"> Drill type (e.g. core, reverse circulation, open-hole hammer, rotary air blast, auger, Bangka, sonic, etc.) and details (e.g. core diameter, triple or standard tube, depth of diamond tails, facesampling bit or other type, whether core is oriented and if so, by what method, etc.). 	<ul style="list-style-type: none"> Standard mud rotary drilling was utilized to re-enter historical oil wells. The wells had been previously plugged and abandoned in some cases, requiring drill out of cement abandonment plugs. All drilling fluids were flushed from the well casing prior to perforation and sampling activities.
Drill Sample Recovery	<ul style="list-style-type: none"> Method of recording and assessing core and chip sample recoveries and results assessed. Measures taken to maximise sample recovery and ensure representative nature of the samples. Whether a relationship exists between sample recovery and grade and whether sample bias may have occurred due to preferential loss/gain of fine/coarse material. 	<ul style="list-style-type: none"> No new drill holes were completed. Therefore, no drill chips, cuttings, or core was available for review. Drilling procedures for well re-entry only produced cuttings from cement plugs.

JORC CODE 2012 “TABLE 1” REPORT

Criteria	JORC Code Explanation	Commentary
Logging	<ul style="list-style-type: none"> Whether core and chip samples have been geologically and geotechnically logged to a level of detail to support appropriate Mineral Resource estimation, mining studies and metallurgical studies. Whether logging is qualitative or quantitative in nature. Core (or costean, channel, etc.) photography. The total length and percentage of the relevant intersections logged. 	<ul style="list-style-type: none"> No new drill holes were completed. Cuttings and core samples retrieved fro UGS and USGS core libraries Not all wells were cored, but cuttings were collected. Cuttings were recovered from mud returns. Sampling of the targeted horizons was carried out at the depths interpreted from the newly completed geophysical logs. Clastic Zones 17, 19, 29, 31 and 33 sampled.
Sub-sampling Techniques and Preparation	<ul style="list-style-type: none"> If core, whether cut or sawn and whether quarter, half or all core taken. • If non-core, whether riffled, tube sampled, rotary split, etc. and whether sampled wet or dry. 	<ul style="list-style-type: none"> Bulk brine samples were stored for potential further analysis.
	<ul style="list-style-type: none"> For all sample types, the nature, quality and appropriateness of the sample preparation technique. Quality control procedures adopted for all sub-sampling stages to maximize representivity of samples. Measures taken to ensure that the sampling is representative of the in-situ material collected, including for instance results for field duplicate/second-half sampling. Whether sample sizes are appropriate to the grain size of the material being sampled. 	<p>Historic Wells</p> <ul style="list-style-type: none"> Sample size and quality were considered appropriate by operators/labs. <p>Re-Entries</p> <ul style="list-style-type: none"> Sampling followed the protocols produced by SRK for lithium brine sampling. Samples were collected in IBC containers and samples taken from them. Duplicate samples kept Storage samples were also collected and securely stored. Bulk samples were also collected for future use. Sample sizes were appropriate for the program being completed.
Quality of Assay Data and Laboratory Tests	<ul style="list-style-type: none"> The nature, quality and appropriateness of the assaying and laboratory procedures used and whether the technique is considered partial or total. For geophysical tools, spectrometers, handheld XRF instruments, etc., the parameters used in determining the analysis including instrument make and model, reading times, calibrations factors applied and their derivation, etc. Nature of quality control procedures adopted (e.g. standards, blanks, duplicates, external laboratory checks) and whether acceptable levels of accuracy (i.e. lack of bias) and precision have been established. 	<ul style="list-style-type: none"> Analysis of brine fluids was completed at several laboratories including, SGS Oil& Chemicals Division, Western Environmental Testing Laboratory (WETLAB), Asset Laboratories, Oilfield Environmental Compliance (OEC), and Enviro-Chem Analytical, Inc. All labs followed a standard QA/QC program that included duplicates, standards, and blind control samples. The quality control and analytical procedures used by the four analytical laboratories are considered to be of high quality. Duplicate and standard analyses are considered to be of acceptable quality. Limited downhole geophysical tools were utilized for orientation within the cased oil wells prior to perforation. These are believed to be calibrated periodically to provide consistent results.

personal use only

JORC CODE 2012 “TABLE 1” REPORT

Criteria	JORC Code Explanation	Commentary
Verification of Sampling and Assaying	<ul style="list-style-type: none"> The verification of significant intersections by either independent or alternative company personnel. The use of twinned holes. Documentation of primary data, data entry procedures, data verification, data storage (physical and electronic) protocols. Discuss any adjustment to assay data. 	<ul style="list-style-type: none"> Accuracy, the closeness of measurements to the “true” or accepted value, was monitored by the insertion of laboratory certified standards. Duplicate samples in the analysis chain were submitted as part of the laboratory batch and results are considered acceptable. Laboratory data reports were verified by the independent CP. Historical assays are recorded in Concentrated Subsurface Brines, UGS Special Publication 13, printed in 1965
Location of Data Points	<ul style="list-style-type: none"> Accuracy and quality of surveys used to locate drill holes (collar and down-hole surveys), trenches, mine workings and other locations used in Mineral Resource estimation. Specification of the grid system used. Quality and adequacy of topographic control. 	<ul style="list-style-type: none"> The location of historical oil wells within the Paradox Basin is well documented. Coordinates of historical oil wells utilized for accessing clastic zones for sampling is provided in Table 9-1 of the report. Re-entries re-surveyed by licensed surveyor.
Data Spacing and Distribution	<ul style="list-style-type: none"> Data spacing for reporting of Exploration Results. Whether the data spacing and distribution is sufficient to establish the degree of geological and grade continuity appropriate for the Mineral Resource and Ore Reserve estimation procedure(s) and classifications applied. Whether sample compositing has been applied. 	<ul style="list-style-type: none"> Data spacing is considered acceptable for a brine sample but has not been used in any Resource calculations. There has been no compositing of brine samples.
Orientation of Data in Relation to Geological Structure	<ul style="list-style-type: none"> Whether the orientation of sampling achieves unbiased sampling of possible structures and the extent to which this is known, considering the deposit type. If the relationship between the drilling orientation and the orientation of key mineralized structures is considered to have introduced a sampling bias, this should be assessed and reported if material. 	<ul style="list-style-type: none"> The Paradox Basin hosts bromine and lithium bearing brines within a sub-horizontal sequence of salts, anhydrite, shale and dolomite. The historical oil wells are vertical (dip -90), perpendicular to the target brine hosting sedimentary rocks. Sampling records did not indicate any form of sampling bias for brine samples.
Sample Security	<ul style="list-style-type: none"> The measures taken to ensure sample security. 	<ul style="list-style-type: none"> Brine samples were moved from the drill pad as necessary and secured. All samples were marked with unique identifiers upon collection
Audits or Reviews	<ul style="list-style-type: none"> The results of any audits or reviews of sampling techniques and data 	<ul style="list-style-type: none"> No audits or reviews have been conducted at this point in time.

JORC CODE 2012 “TABLE 1” REPORT

Section 2 Reporting of Exploration Results

(Criteria in this section apply to all succeeding sections.)

Criteria	JORC Code Explanation	Commentary
<i>Mineral Tenement and Land Tenure Status</i>	<ul style="list-style-type: none"> Type, reference name/number, location and ownership including agreements or material issues with third parties such as joint ventures, partnerships, overriding royalties, native title interests, historical sites, wilderness or national park and environmental settings. The security of the tenure held at the time of reporting along with any known impediments to obtaining a license to operate in the area. 	<ul style="list-style-type: none"> The Paradox Basin Brine Project is located approximately 12 km west of Moab, Utah, USA, and encompasses a land position of 8,947 hectares. The land position is constructed from 1,006 Federal placer mineral claims, and one mineral lease from the State of Utah. A1 Lithium has 50% ownership of 87 of the 1,006 mineral claims through a earn-in joint venture with Voyageur Mineral Ltd. All other claims and leases are held 100% by Anson's U.S. based subsidiary, A1 Lithium Inc. The claims/leases are in good standing, with payment current to the relevant governmental agencies.
<i>Exploration Done by Other Parties</i>	<ul style="list-style-type: none"> Acknowledgment and appraisal of exploration by other parties. 	<ul style="list-style-type: none"> Historical exploration for brines within the Paradox Basin includes only limited work in the 1960s. No brine resource estimates have been completed in the area, nor has there been any historical economic production of bromine or lithium from these fluids. The historical data generated through oil and gas development in the Paradox Formation has supplied some information on brine chemistry, however none of this work is considered complete for inclusion in a formal resource estimate.
<i>Geology</i>	<ul style="list-style-type: none"> Deposit type, geological setting and style of mineralization. 	<ul style="list-style-type: none"> The geology of the Paradox Formation indicates a restricted marine basin, marked by 29 evaporite sequences. Brines that host bromine and lithium mineralization occur within the saline facies of the Paradox Formation and are generally hosted in the more permeable dolomite sediments. Controls on the spatial distribution of certain salts (boron, bromine, lithium, magnesium, etc.) within the clastic aquifers of the Paradox Basin is poorly understood but believed to be in part dictated by the geochemistry of the surrounding depositional cycles, with each likely associated with a unique geochemical signature. The source and age of the brine requires further investigation.

JORC CODE 2012 “TABLE 1” REPORT

Criteria	JORC Code Explanation	Commentary
Drill Hole Information	<ul style="list-style-type: none"> A summary of all information material to the understanding of the exploration results including a tabulation of the following information for all Material drill holes: <ul style="list-style-type: none"> easting and northing of the drill hole collar elevation or RL (Reduced Level – elevation above sea level in meters) of the drill hole collar dip and azimuth of the hole down hole length and interception depth hole length. If the exclusion of this information is justified on the basis that the information is not Material and this exclusion does not detract from the understanding of the report, the Competent Person should clearly explain why this is the case. 	<ul style="list-style-type: none"> Four existing oil wells were re-entered and worked over in 2018 and 2019 to collect brine samples. Although these wells may be directional, all wells are vertical (dip -90, azimuth 0 degrees) through the stratigraphy of interest. Detailed historical files on these oil wells were reviewed to plan the re-entry, workover and sampling activities. Following geophysical logging to confirm orientation within the cased well, potential production intervals were perforated, isolated and sampled. The target horizons in the Paradox Formation are approximately 1,800 meters below ground surface.
Data Aggregation Methods	<ul style="list-style-type: none"> In reporting Exploration Results, weighting averaging techniques, maximum and/or minimum grade Brine samples taken in holes were averaged (arithmetic average) without 14 Criteria JORC Code explanation Commentary truncations (e.g. cutting of high grades) and cut-off grades are usually Material and should be stated. Where aggregate intercepts incorporate short lengths of high-grade results and longer lengths of low-grade results, the procedure used for such aggregation should be stated and some typical examples of such aggregations should be shown in detail. The assumptions used for any reporting of metal equivalent values should be clearly stated. 	<ul style="list-style-type: none"> No weighting or cut-off grades have been applied.
Relationship Between Mineralization Widths and Intercept Lengths	<ul style="list-style-type: none"> These relationships are particularly important in the reporting of Exploration Results. If the geometry of the mineralization with respect to the drill hole angle is known, its nature should be reported. If it is not known and only the down hole lengths are reported, there should be a clear statement to this effect (e.g. 'down hole length, true width not known'). 	<ul style="list-style-type: none"> The sediments hosting the brine aquifer are interpreted to be essentially perpendicular to the vertical oil wells. Therefore, all reported thicknesses are believed to be accurate. Brines are collected and sampled over the entire perforated width of the clastic zones of interest.

personal use only

JORC CODE 2012 “TABLE 1” REPORT

Criteria	JORC Code Explanation	Commentary
<i>Diagrams</i>	<ul style="list-style-type: none"> • <i>Appropriate maps and sections (with scales) and tabulations of intercepts should be included for any significant discovery being reported. These should include, but not be limited to a plan view of drill hole collar locations and appropriate sectional views.</i> 	<ul style="list-style-type: none"> • A diagram is presented in the text showing the location of the properties and re-entered oil wells.
<i>Balanced Reporting</i>	<ul style="list-style-type: none"> • <i>Where comprehensive reporting of all Exploration Results is not practicable, representative reporting of both low and high grades and/or widths should be practiced to avoid misleading reporting of Exploration Results.</i> 	<ul style="list-style-type: none"> • All data generated by Anson through re-entry, workover, and sampling of historical oil wells is presented. No newly generated data has been withheld or summarized.
<i>Other Substantive Exploration Data</i>	<ul style="list-style-type: none"> • <i>Other exploration data, if meaningful and material, should be reported including (but not limited to): geological observations; geophysical survey results; geochemical survey results; bulk samples – size and method of treatment; metallurgical test results; bulk density, groundwater, geotechnical and rock characteristics; potential deleterious or contaminating substances.</i> 	<ul style="list-style-type: none"> • All available current exploration data has been presented.
<i>Further Work</i>	<ul style="list-style-type: none"> • <i>The nature and scale of planned further work (e.g. tests for lateral extensions or depth extensions or large-scale step-out drilling).</i> • <i>Diagrams clearly highlighting the areas of possible extensions, including the main geological interpretations and future drilling areas, provided this information is not commercially sensitive.</i> 	<ul style="list-style-type: none"> • Additional well re-entries and sampling planned following acceptance of Plan of Operations with BLM and completion of an Environmental Assessment. • Future well re-entries will focus on wells located on southern portion of claims. • Future well re-entries will include further hydrogeological investigations.

personal use only

JORC CODE 2012 “TABLE 1” REPORT

Section 3 Estimation and Reporting of Mineral Resource

(Criteria listed in section 1 and where relevant in section 2, also apply to this section.)

Criteria	JORC Code Explanation	Commentary
Database integrity	<ul style="list-style-type: none"> Measures taken to ensure that data has not been corrupted by, for example, transcription or keying errors, between its initial collection and its use for Mineral Resource estimation purposes. Data validation procedures used. 	<ul style="list-style-type: none"> Data has been verified by company personnel. Historic data used in the estimation has been sourced from Utah Geological Survey publications.
Site visits	<ul style="list-style-type: none"> Comment on any site visits undertaken by the Competent Person and the outcome of those visits. If no site visits have been undertaken indicate why this is the case. 	<ul style="list-style-type: none"> The competent person has not visited site. Other consultants who have provided data and information for the estimate were on-site to supervise the well re-entry, sampling and assaying procedures.
Geological interpretation	<ul style="list-style-type: none"> Confidence in (or conversely, the uncertainty of) the geological interpretation of the mineral deposit. Nature of the data used and of any assumptions made. The effect, if any, of alternative interpretations on Mineral Resource estimation. The use of geology in guiding and controlling Mineral Resource estimation. The factors affecting continuity both of grade and geology. 	<ul style="list-style-type: none"> The geological interpretation, location and depth of the brine bearing unit is very well known and documented through the drilling of hundreds of oil and gas wells over the past century. The Paradox Basin is a large, deep basin containing thousands of metres of sediments containing various levels of oil, gas and brine. The sedimentary layers have been correlated over most, if not all, of the basin. This enables an accurate assessment of the position of the brine units, CZ17, CZ19, CZ29, CZ31 and CZ33.
Dimensions	<ul style="list-style-type: none"> The extent and variability of the Mineral Resource expressed as length (along strike or otherwise), plan width, and depth below surface to the upper and lower limits of the Mineral Resource. 	<ul style="list-style-type: none"> The brine bearing units are encountered at depth over the entire Anson claim area. Available data indicates that the units contains brine throughout its extent within the Anson claims The Anson claims cover an area of about 10km x 10km and this entire area has been covered by the estimation. Within the claim area the brine units are found at vertical depths of between 1,450m to 2,250m below surface. The producing units averages 2m-6m in thickness.

JORC CODE 2012 “TABLE 1” REPORT

<p><i>Estimation and modelling techniques</i></p>	<ul style="list-style-type: none"> • <i>The nature and appropriateness of the estimation technique(s) applied and key assumptions, including treatment of extreme grade values, domaining, interpolation parameters and maximum distance of extrapolation from data points. If a computer assisted estimation method was chosen include a description of computer software and parameters used.</i> • <i>The availability of check estimates, previous estimates and/or mine production records and whether the Mineral Resource estimate takes appropriate account of such data.</i> • <i>The assumptions made regarding recovery of by-products.</i> • <i>Estimation of deleterious elements or other non-grade variables of economic significance (e.g. sulphur for acid mine drainage characterisation).</i> • <i>In the case of block model interpolation, the block size in relation to the average sample spacing and the search employed.</i> • <i>Any assumptions behind modelling of selective mining units.</i> • <i>Any assumptions about correlation between variables.</i> • <i>Description of how the geological interpretation was used to control the resource estimates.</i> • <i>Discussion of basis for using or not using grade cutting or capping.</i> • <i>The process of validation, the checking process used, the comparison of model data to drill hole data, and use of reconciliation data if available.</i> 	<ul style="list-style-type: none"> • The brine grades were modelled using inverse distance squared grade interpolation. • A single composite for the producing unit in each well was used to estimate grades. • Lithium, Bromine, Iodine, porosity and brine density were all modelled. • A search box was used to eliminate the edge effect of using a search ellipse. The search box was 8000m x 8000m to ensure all the project area was covered. • Minimum samples used in the estimation was 1 and the maximum was 3. • A total of 202 wells were used to determine the depth and thickness of the brine producing units. Lithium grades are available for a total of 8 wells, some of which are outside the Anson claim; their grades were interpolated into the Anson claims. • Bromine data was from 7 wells and Iodine from 4. There were 4 density and 3 porosity measurements. • The parent block size used was 500m x 500m with sub blocks to 20m x 20m to enable adequate definition of the brine unit. • There is correlation between variables based on the total dissolved solid (TDS) content of the brine. • Cutting of assays was not appropriate as grade is based on the TDS levels. Mapping of brine saturation levels indicates that the Paradox Basin does contain higher levels of saturation at its deeper center. • One well with a high historic lithium grade of 1,700ppm was not included in the estimation as it is considered a potential outlier. • The brine is contained within the producing units (Clastic Zones 17,19, 31,33). The contained brine is estimated by multiplying the volume by the effective porosity and then by the brine density. Test-work within clastic zone 31 was conducted to measure effective porosity. This was used to estimate effective porosity in CZ31. The effective porosity in Big Flat 2 was estimated at 14.9%. The ratio of this to the total porosity of 21% of Big Flat 2, measured on neutron logs, was applied to other total porosity measurements in CZ31. All other clastic zones were assumed to have an effective porosity of 14%.
---	---	--

personal use only

JORC CODE 2012 “TABLE 1” REPORT

Criteria	JORC Code Explanation	Commentary
Moisture	<ul style="list-style-type: none"> Whether the tonnages are estimated on a dry basis or with natural moisture, and the method of determination of the moisture content. 	<ul style="list-style-type: none"> Tonnages are reported as in-situ, super saturated brine in liquid form. Density of the brine is approximately 1.2t/m³. Tonnages of product equivalent eg lithium carbonate are reported as dry tonnes.
Cut-off parameters	<ul style="list-style-type: none"> The basis of the adopted cut-off grade(s) or quality parameters applied. 	<ul style="list-style-type: none"> No cut-off grades were applied.
Mining factors or assumptions	<ul style="list-style-type: none"> Assumptions made regarding possible mining methods, minimum mining dimensions and internal (or, if applicable, external) mining dilution. It is always necessary as part of the process of determining reasonable prospects for eventual economic extraction to consider potential mining methods, but the assumptions made regarding mining methods and parameters when estimating Mineral Resources may not always be rigorous. Where this is the case, this should be reported with an explanation of the basis of the mining assumptions made. 	<ul style="list-style-type: none"> Testwork on re-entering historic wells has indicated that brine can be recovered from the producing unit. To date four drill wells have been re-entered successfully with pumping tests producing mineral bearing brine. This resource estimate represents a contained brine figure. Brine production will have a yield factor applied as not all of the brine will be able to be extracted from the clastic zone.
Metallurgical factors or assumptions	<ul style="list-style-type: none"> The basis for assumptions or predictions regarding metallurgical amenability. It is always necessary as part of the process of determining reasonable prospects for eventual economic extraction to consider potential metallurgical methods, but the assumptions regarding metallurgical treatment processes and parameters made when reporting Mineral Resources may not always be rigorous. Where this is the case, this should be reported with an explanation of the basis of the metallurgical assumptions made. 	<ul style="list-style-type: none"> No assumptions regarding the metallurgical or recoverability characteristics of the brine have been assumed in the estimation. However, lithium carbonate has been produced from bench top test-work from recently collected brine samples.
Environmental factors or assumptions	<ul style="list-style-type: none"> Assumptions made regarding possible waste and process residue disposal options. It is always necessary as part of the process of determining reasonable prospects for eventual economic extraction to consider the potential environmental impacts of the mining and processing operation. While at this stage the determination of potential environmental impacts, particularly for a greenfields project, may not always be well advanced, the status of early consideration of these potential environmental impacts should be reported. Where these aspects have not been considered this should be reported with an explanation of the environmental assumptions made. 	<ul style="list-style-type: none"> Spent brines following processing and recovery of bromine and lithium will be injected back into receptive brine horizons in the lower Paradox Formation using Class V-1c Underground Injection Control (UIC) wells located near the processing facility. Spent brine will have similar characteristics to fresh brine minus concentrations of bromine, lithium and other transition metals captured through filtration. No waste products are left on site. No environmental assumptions were used in this estimation.

JORC CODE 2012 “TABLE 1” REPORT

Criteria	JORC Code Explanation	Commentary
<i>Bulk density</i>	<ul style="list-style-type: none"> • <i>Whether assumed or determined. If assumed, the basis for the assumptions. If determined, the method used, whether wet or dry, the frequency of the measurements, the nature, size and representativeness of the samples.</i> • <i>The bulk density for bulk material must have been measured by methods that adequately account for void spaces (vugs, porosity, etc.), moisture and differences between rock and alteration zones within the deposit.</i> • <i>Discuss assumptions for bulk density estimates used in the evaluation process of the different materials.</i> 	<ul style="list-style-type: none"> • Brine density measurements were based on samples from the pump tests carried out by Anson in 2018 and 2019. • Data was measured in commercial laboratories. • Total Porosity measurements were taken utilising a combination of neutron density logs and sonic logs for the three re-entry holes. • Permeability was measured during the well re-entry. Skyline returned 6,543 md (milli darcys) and Long Canyon 1,698 md. These indicate high levels of permeability.
<i>Classification</i>	<ul style="list-style-type: none"> • <i>The basis for the classification of the Mineral Resources into varying confidence categories.</i> • <i>Whether appropriate account has been taken of all relevant factors (ie relative confidence in tonnage/grade estimations, reliability of input data, confidence in continuity of geology and metal values, quality, quantity and distribution of the data).</i> • <i>Whether the result appropriately reflects the Competent Person's view of the deposit.</i> 	<ul style="list-style-type: none"> • The Mineral Resource estimate is reported here in compliance with the 2012 Edition of the 'Australasian Code for Reporting of Exploration Results, Mineral Resources and Ore Reserves' by the Joint Ore Reserves Committee (JORC). The resource was classified as an Indicated and Inferred Mineral Resource based on data quality, sample spacing, and lode continuity. • The recent pump tests carried out by Anson have provided samples with a known provenance and assaying technique. • These assays were used as the basis for the indicated resources. <p>JORC Resource - CZ31</p> <ul style="list-style-type: none"> • Indicated Resources are within 2km of the well. • From 2 to 4km the resource is categorized as Inferred. • Outside 4km the brine mineralisation is encompassed in the Exploration Target. <p>JORC Resource – CZ 17, 19, 29 & 33</p> <ul style="list-style-type: none"> • Indicated Resources are within 1km of the well. • From 1 to 3km the resource is categorized as Inferred • Outside 3km the brine mineralisation is encompassed in the Exploration Target. • The classification appropriately represents the level of confidence in the contained mineralisation and it reflects the competent persons view of the deposit.
<i>Audits or reviews</i>	<ul style="list-style-type: none"> • <i>The results of any audits or reviews of Mineral Resource estimates.</i> 	<ul style="list-style-type: none"> • No audits or review of the Mineral Resource estimate has been conducted.

JORC CODE 2012 “TABLE 1” REPORT

Criteria	JORC Code Explanation	Commentary
<p><i>Discussion of relative accuracy/ confidence</i></p>	<ul style="list-style-type: none"> • <i>Where appropriate a statement of the relative accuracy and confidence level in the Mineral Resource estimate using an approach or procedure deemed appropriate by the Competent Person. For example, the application of statistical or geostatistical procedures to quantify the relative accuracy of the resource within stated confidence limits, or, if such an approach is not deemed appropriate, a qualitative discussion of the factors that could affect the relative accuracy and confidence of the estimate.</i> • <i>The statement should specify whether it relates to global or local estimates, and, if local, state the relevant tonnages, which should be relevant to technical and economic evaluation. Documentation should include assumptions made and the procedures used.</i> • <i>These statements of relative accuracy and confidence of the estimate should be compared with production data, where available</i> 	<ul style="list-style-type: none"> • The geology and stratigraphy of the Paradox Basin is very well known. • The brine unit the subject of this resource estimation is known to contain super saturated brine at pressure from the drilling of many oil and gas wells. • The resource is reported as in-situ tonnes of mineralisation. • Further testwork is required to enable recoverable volumes of brine to be estimated.

personal use only

ANNEXURE A: PERMITTING

PERMIT/AUTHORIZATION (AGENCY)	STUDIES	MITIGATION REQUIREMENTS	MONITORING	STATUS
<i>Exploration Work</i>				
NOI to Conduct Exploration (DOGM)	Clearance surveys, including archaeological, biologic, and vegetation surveys	None	None	Active
Notice (BLM)	Clearance surveys, including archaeological, biologic, and vegetation surveys	None	None	Active
<i>Commercial Facility</i>				
Notice of Intention to Commence Large Mining Operations (DOGM)	Operation and Reclamation plans, clearance surveys as determined by the state	Reclamation Plan to include plan for protection of soils, water resources, T&E species, slope stability, air quality, and public health.	As required in the approved Operations and Reclamation Plans	Application package with final Operations and Reclamation Plans, plant design, and clearance surveys to be completed
SULA Lease (SITLA)	Clearance surveys, including archaeological, biologic, and vegetation surveys are anticipated to be required prior to lease issuance	Not required unless clearance surveys identify sensitive receptors	Not required unless clearance surveys identify sensitive receptors	SULA lease application obtained
Air Quality Approval Order (DAQ)	Emissions Inventory- verification of emission sources	Application should include any identified mitigation measures (Best Available Technology Controls) and monitoring needs	As determined during application review	Emissions inventory and permit preparation to be completed
Construction General Permit for Stormwater (DWQ)	Storm Water Pollution Prevention Plan (SWPPP) to be prepared and kept onsite	Approved BMPs as outlined in the SWPPP	Standard inspections every 2 weeks and within 24 hours of a qualifying storm event	SWPPP and online application to be completed
Multi-Section Industrial General Permit for Stormwater (DWQ)	Storm Water Pollution Prevention Plan (SWPPP) to be prepared and kept onsite	Approved BMPs as outlined in the SWPPP	As outlined in Section 5 of the Appendix II.AD Storm Water Discharges Associated with Industrial Activity from Non-Classified Facilities General Permit	SWPPP and online application to be completed
UIC Permit (DWQ)	Formation testing, mechanical well casing testing, proof of protection of nearby underground sources of drinking water (USDW),	None required at this time	Monitoring and sampling program to be submitted and approved as part of permit approval process	Well testing and application package to be completed

personal use only

ANNEXURE A: PERMITTING

PERMIT/AUTHORIZATION (AGENCY)	STUDIES	MITIGATION REQUIREMENTS	MONITORING	STATUS
	and injection well construction and operation plans			
Conditional Use Permit and Height Variance (Grand County)	Detailed site engineering and environmental evaluation to be completed; height variance process to be completed prior to Planning Commission Hearing	TBD by County Planning Commission	TBD by County Planning Commission	Application package to be completed
Building and Safety Permits (Grand County)	Detailed engineering design	TBD during application processing	TBD during application processing	Application packages to be completed
<i>Pipeline Permits</i>				
Plan of Operations (BLM)	Clearance surveys, including archaeological, biologic, and vegetation surveys are anticipated to be required to support NEPA	To be determined in EA document; no known nearby sensitive receptors	To be determined in EA document; no known nearby sensitive receptors	Clearance surveys and Plan of Operations to be completed
ROW Lease (SITLA)	Clearance surveys, including archaeological, biologic, and vegetation surveys are anticipated to be required prior to lease issuance;	Not required unless clearance surveys identify sensitive receptors	Not required unless clearance surveys identify sensitive receptors	Clearance surveys to be completed; SULA lease application in process
ROW Use Agreements	ROW use agreements with existing ROW operators recommended	N/A	N/A	ROW use agreement discussions to be held with existing operators
<i>Brine Well Field Permits</i>				
Plan of Operations (BLM)	Clearance surveys, including archaeological, biologic, and vegetation surveys are anticipated to be required to support NEPA process	To be determined in EA document; no known nearby sensitive receptors	To be determined in EA document; no known nearby sensitive receptors	Plan of Operations submitted
NOI to Conduct Exploration (DOGM)	Clearance surveys, including archaeological, biologic, and vegetation surveys	None	None	Clearance surveys and NOIs packages to be completed

personal use only